

# Wireless World

RADIO and ELECTRONICS

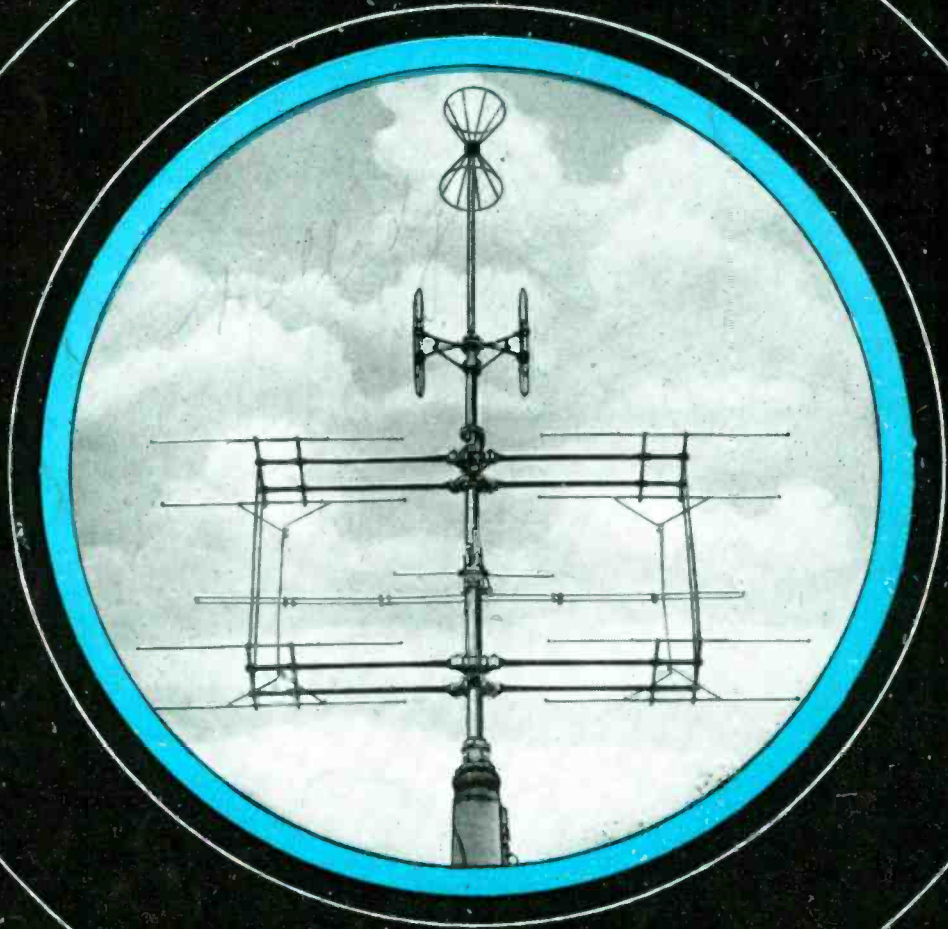

OCT. 1945

1/6

Vol. LI No. 10

IN THIS  
ISSUE:

RADAR AND THE INDUSTRY



# Rola Components

*The best you can buy -  
made by the organisation  
with the greatest experience*

**BRITISH Rola LIMITED**  
GEORGIAN HOUSE, BURY STREET, ST. JAMES'S  
LONDON S.W.1. ENGLAND

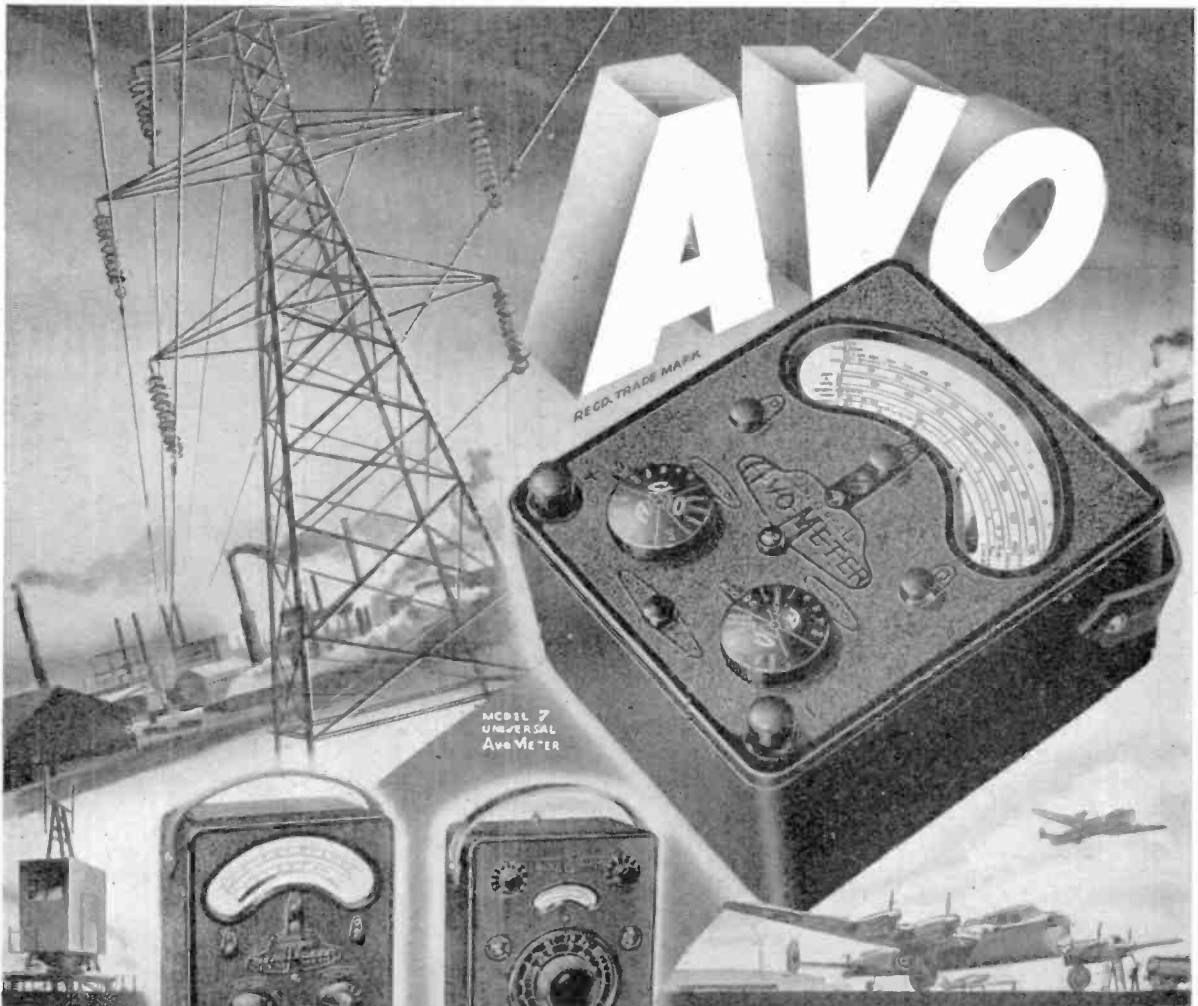

REGD. TRADE MARK

MODEL 7  
UNIVERSAL  
AVOMETER



MODEL 40  
UNIVERSAL  
AVOMETER



THE "AVO"  
TEST  
BRIDGE

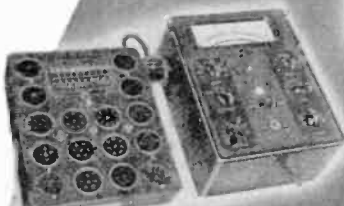

THE "AVO"  
VALVE TESTER

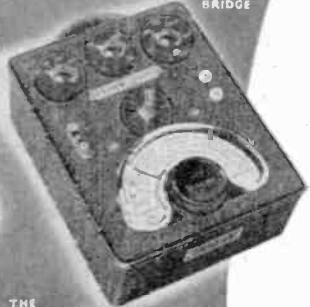

THE  
ALL WAVE  
"AVO" OSCILLATOR

THE world-wide use of "AVO" Electrical Testing Instruments is striking testimony to their outstanding versatility, precision, and reliability. In every sphere of electrical test work they are maintaining the "AVO" reputation for dependable accuracy, which is often used as a standard by which other instruments are judged.

**THE AUTOMATIC COIL WINDER & ELECTRICAL EQUIPMENT CO., LTD.**  
 WINDER HOUSE · DOUGLAS STREET · LONDON · S.W.1 · TELEPHONE: VICTORIA 3400/7

# CABLES FOR RADAR

MANUFACTURED  
BY

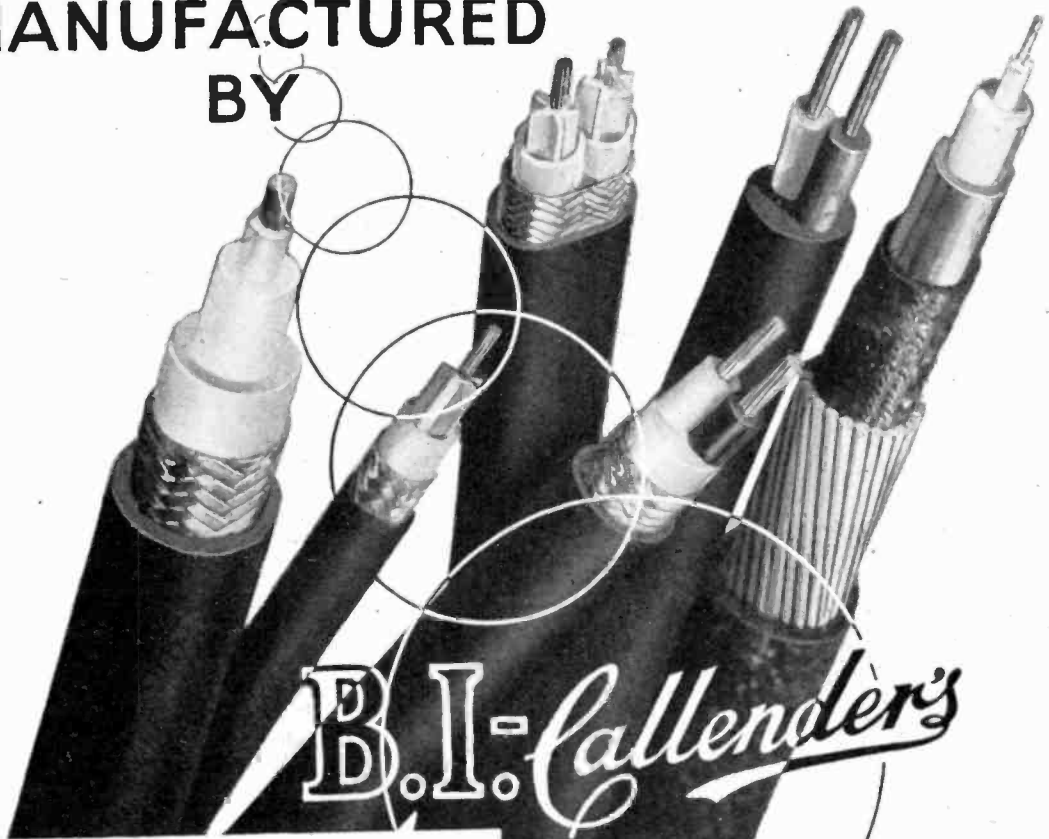

**B.I. Callender's**

We are specialists in the manufacture of all types of low loss and low capacity cables for use at high frequencies. Our research and technical services are available in connection with high frequency cable problems relating to electronics, television and telecommunications.

**BRITISH INSULATED CALLENDER'S CABLES LIMITED**  
103, Mount Street • London, W.C.1



**"Everything  
O.K. Sir !"**

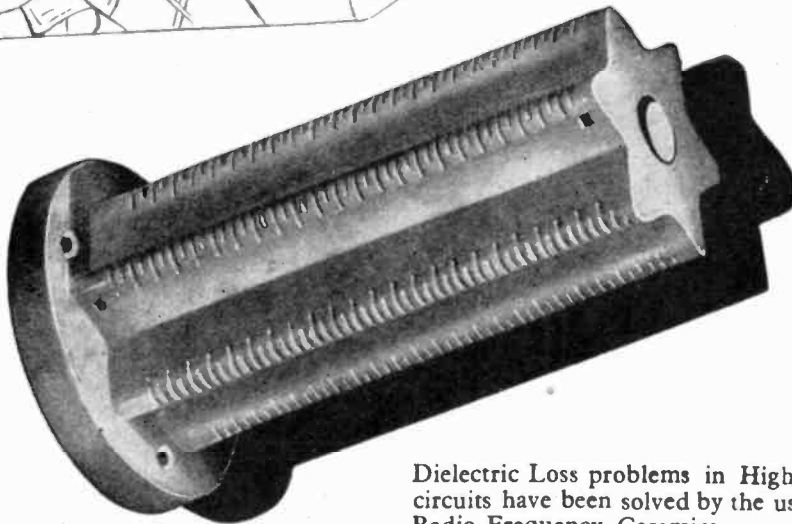

Dielectric Loss problems in High Frequency circuits have been solved by the use of Bullers Radio-Frequency Ceramics.

Many years of research and development in our Laboratories have brought these materials to a high degree of efficiency.

They are in constant use for transmission and reception and play an important part in maintaining communication under all conditions.

**Made in Three  
Principal Materials**

**FREQUELEX**

An insulating material of Low Dielectric loss. For Coil formers, Aerial Insulators, Valve Holders, etc.

**PERMALEX**

A High Permittivity Material. For the construction of Condensers of the smallest possible dimensions.

**TEMPLEX**

A Condenser Material of medium permittivity. For the construction of Condensers having a constant capacity at all temperatures.



**BULLERS LTD.,**  
THE HALL, OATLANDS DRIVE,  
WEYBRIDGE, SURREY.

Telephone : Walton-on-Thames 2451  
Manchester Office : 196, Deansgate, Manchester.

# Bullers

**LOW LOSS CERAMICS**



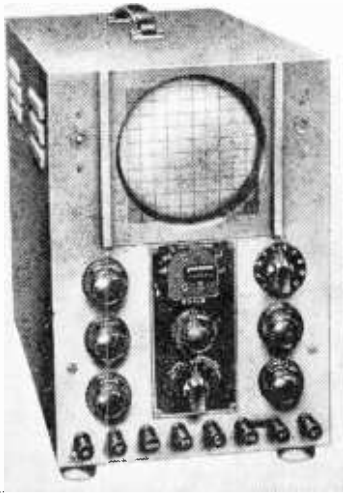

**STATIC TWO-DIMENSIONAL**  
visual delineation of any recurrent  
law.

**RELATIVE TIMING OF EVENTS**  
and other comparative measure-  
ments with extreme accuracy.

**PHOTOGRAPHIC RECORDING**  
of transient phenomena.

**SIMULTANEOUS INDICATION**  
of two variables on a common  
time axis.

INDUSTRIAL INDICATING and TESTING afford in-  
creasing scope for the Cathode Ray Tube as the only  
device with the above inherent features, of which the  
last is unique in the Cossor DOUBLE BEAM Tube.

The Model 339 Cossor Oscillograph thus equipped  
is invaluable on all problems of research, production  
or operational testing, when the effect examined is  
applied as a voltage. When recurrent the traces are  
studied visually and when transient are recorded  
photographically, using Model 427 camera.

**A. C. COSSOR LTD.,**  
INSTRUMENT DEPT.

Cossor House, London, N.5

'Phone: CANonbury 1234 (33 lines).

'Grams: Amplifiers Phone London.

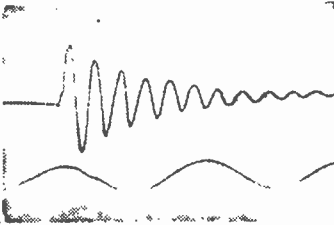

# Wharfedale FACTORY SPEAKER



SIZE  
OF  
CABINET  
15½" x 12½"  
x 6½"

Fitted with Metal Grilles front and back.  
Available WITH or WITHOUT Handle,  
Transformer or Volume Control.  
10-inch BRONZE UNIT FOR 5 WATTS.  
10-inch GOLDEN UNIT FOR 8 WATTS.

Made and Guaranteed by

**WHARFEDALE WIRELESS WORKS**  
HUTCHINSON LANE, BRIGHOUSE, YORKS

'Phone: Brighouse 50.

'Grams: "Wharfedel, Brighouse"

**ADASTRA**  
SECTIONAL STEEL  
RADIO MASTS  
Send for Catalogue **WD/330**  
POLES LTD BIRMINGHAM 24

# LINAGLOW LIMITED

## LINTONE

### 5-VALVE MIDGET SUPERHET CONSTRUCTORS KIT

Complete with Cabinet.  
16-50, 200-550 metres.

**A SUPER-SENSITIVE AND SELECTIVE CIRCUIT.**  
Brief specification : Frequency changer, 6 tuned circuit, 465 K.C.'s iron cored I.F.'s, 4-watt output. P.M. speaker and output transformer, all valves, chassis, practical and theoretical diagrams. Parts list, nuts, bolts and wire and modern cabinet, dimensions, 12in. x 8in. x 6in. deep. Ready to assemble. 200/250 volts. A.C. Parts, new, ex-television. Including purchase tax, .. **13½ Gns.**  
Case and packing, 10/- extra.

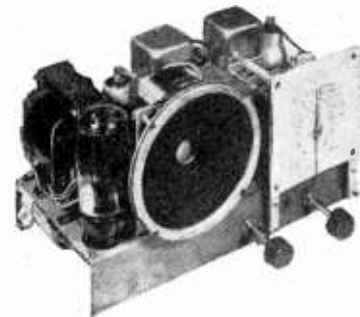
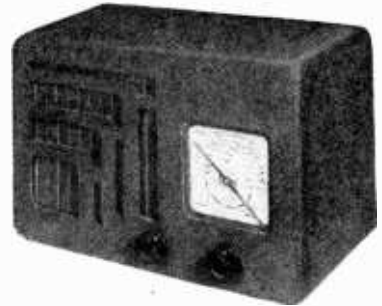

### WE CAN NOW OFFER FROM STOCK THE FOLLOWING ELECTROLYTICS.

6-mfd. x 50 v. tubular, 1/8; 25-mfd. x 35 v. tubular, 1/8; 25-mfd. x 25 v. tubular, 2/-; 50-mfd. x 12 v. tubular, 2/-; 8-mfd. 500 v. tubular tag end, 4/3; 8 x 8 mfd., 500 v., tubular tag end, 6/3; 32-mfd., 350 v., tubular tag end, 6/3; 4-mfd., 450 v., tubular tag end, 4/6; 8-mfd., 500 v. block, 4/4; 4-mfd., 440 v. wet aluminium can, 7/6; 8-mfd., 440 v. wet aluminium can, 9/6; 16-mfd., 440 v. wet aluminium can, 11/6.

**LOUDSPEAKER TRANSFORMERS.** Pentode output, 40:1, 50 m.a., 4/-; Midget multi-ratio, 60:1, 80:1, 40 m.a., 7/6; Multi-ratio, 40:1, 60:1, 80:1, and push-pull, 80 m.a., 10/6; Pentode output, 12/16 ohms, 100 m.a., 12/6; heavy duty, multi-ratio, 24:1, 41:1, 48:1, 58:1, 82:1, 116:1 and P.P., 80 m.a., 15/6; 3:1 Inter-valve, 10/6; push-pull output, 20-watt, 4,000-0-4,000 primary, 2.5, 7.5 and 12/16 ohms, secondary, 25/-.

**P.M. LOUDSPEAKERS.** 3 ohm, Voice coil, Rola, Goodman and Celestion, 6in., with transformer, 30/-; 8in., with transformer, 32/6; 2 1/2in., 27/6; 3 1/2in., 30/-; 5in., 22/6; 8in., 24/-; 12in., 28 1/2s.; 10in. Mains energised 250 ohms, 35/-; B.T.H. Model R.K., 10in. Mains, energised loudspeakers, 1,000 ohms field, 15 ohms, speech; weight, 28 lbs.; reconditioned as new; ideal for P.A. work, 28 6s. 10in. Mains, energised 1,140 ohms, with transformer, 45/-; See transformers above to suit.

### EXTENSION LOUDSPEAKERS

#### IN BAKELITE MOULDED CASES

Brown, with White, Green or Red grille. State colour preferred.  
Dimensions 11 x 12 x 5in., fitted with 8in. P.M. Speaker and Pentode Transformer, excellent in appearance and performance.

**45** - complete.

**AERIAL AND OSCILLATOR COILS.** Best D.S.O. wire-wound, colour coded on bakelite formers. Short, medium and long-wave, 15/50 m., 200/550 m., 1,000/2,000 m., with circuit diagram, 15/- the set.

**I.F. TRANSFORMERS.** 465 K.C.'s iron-cored, lits wound, alum. can. Limited quantity, 17/6, matched pair. 9/6 ea. S.M. and L.T.R.F. COILS. Philips, best quality in screened aluminium can; 17-51, 220-585; 725-2,000 metres. (These coils equal to performance of superhet.) Complete with diagram, 9/6 the pair.

**M. and L. T.R.F. AERIAL COILS.** Aluminium screened Philips, 200-585, 725-2,000 metres. Complete with diagram, 2/9 each.

**WAVE CHANGE SWITCH.** To suit all above coils, 5/3.

#### 2-SPECIAL KIT OFFERS

**KIT 1.**—Tuning heart, suitable for 6-valve superhet, comprising variable condenser and slow-motion drive, set of iron-cored I.F.'s 465 K.C.'s Litz wound, aerial coil, R.F. transformer and oscillator coil. All trimmers and padders with wave change switch for 6-wave bands. S.M. and L. Also circuit diagram for complete set, 23 8s. 6d.  
**KIT 2.**—Tuning heart for 6-valve superhet, comprising variable condenser, and slow-motion drive, set of iron-cored I.F.'s 465 K.C.'s Litz wound, aerial coil and oscillator coil. All trimmers and padders with wave change switch for 3-wave bands. S.M. and L. Also circuit diagram for complete set, 22 18s. 6d.

### "LIBERTY SIX" ALL-WAVE 6-VALVE CONSTRUCTORS KIT

16-50, 200-560, 1,000-2,000 metres.

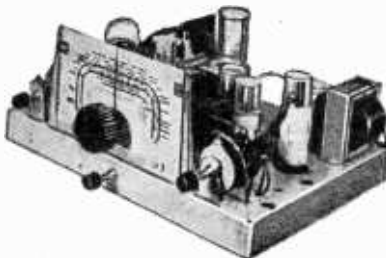

### A SUPER-SENSITIVE & SELECTIVE CIRCUIT HUNDREDS OF SATISFIED USERS.

Brief specification : Frequency changer with two valves, separate oscillator, six tuned circuit, 465 K.C.'s iron-cored I.F.'s. Separate tone and volume controls, 5-watt output, 8in. P.M. Speaker, with baffle and output transformer, all valves, chassis, Practical and Theoretical diagrams. Parts list, Nuts, Bolts and Wire, ready to assemble. 200/250 volts. A.C. Parts, new, ex-television. **16 Gns.**  
Including purchase tax, ..  
Case and packing, 5/- extra.

### T.R.F. 3-WAVEBAND 4-VALVE CONSTRUCTORS KIT

17-2,000 metres.

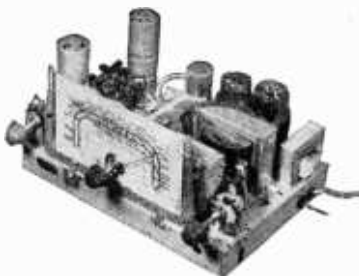

Parts, new, ex-television, aluminium screened coils, excellent short-wave reception (the special coils used in this circuit give a performance equal to a superhet.), 4½ watts output, complete with loudspeaker, all parts, wiring and theoretical diagram—nothing extra to purchase. Chassis dim.: 12in. x 6in. x 6in. to top of dial  
200/250 v. A.C., including tax .. **11½ Gns.**  
Case and packing, 5/- extra.

**VOLUME CONTROLS.** 1, 5, 10, 20, 25, 50 and 100 thousand ohms. ½, 1 and 2 meg., without switch, 4/3 each. An above, with switch, 6/-; 100,000 ohms, ½-mer., double-pole switch, best American, 6/3; 2,000 ohm. only, wire wound, 2/3; 1,000 ohms. only, carbon screw adjustment, 1/6. Midget ½-meg., with switch, 5/6; less switch, 2/6.

**WESTINGHOUSE METAL RECTIFIERS, EX-G.P.O.** Suitable for chargers, etc., H/wave, H.T., 150/400 v., 50/200 m.a., 15/-.

**WANDER PLUGS.** In 2 colours, 2/- per doz.  
**ALUMINIUM CHASSIS.** Partially Drilled. Dimensions, 10½" x 9" x 2½" and 10½" x 10½" x 2½", 16 gauge. Either type 7/6 each.

**CAR AERIALS.** Telescopic, scuttle fixing, extending to 4ft. 6in., carbon insulators, nickel-plated, 22/6.

**VIBRATORS.** 4-pin, 6-volt, best quality American, 10/6.

**METAL RECTIFIERS, ex-G.P.O.** Suitable for small chargers, relays, etc., 12 v., full wave, 100 m.a., 5/-; 6 v. H/wave, 50 m.a., 5/-; 4 v. H/wave, 30 m.a., 4/-; 2 v. H/wave, 16 m.a., 4/-; H1 2½ v., D.C., 10 m.a., 3/6.

**SPECIAL OFFER BATTERY CHARGERS.** 1-amp. type, 2-, 6- or 12-volt output. Finished in black metal cabinet. Small and compact, 23 18s. 6d. each.

**ELECTRIC KETTLES.** 4-pint. Vitreous enamel, 950 watt, 200/220, 230/250 v., complete with lead and adaptor, 41/3.

### DE LUXE ALL-WAVE SERVICE SIGNAL GENERATOR

A.C. mains, 200/250 v. 50 cycles, range covers from 30 M.C. to 100 K.C. all fundamentally in 5 bands without gaps. 8/M dial. Direct calibration in frequencies. Coarse and fine output attenuator. Internal modulation, 400 c/s. Iron-cored coils. The generator is entirely screened in heavy metal cabinet. Dim. 10in. x 10in. x 12in., 16 gas. Case and packing, 10/- extra.

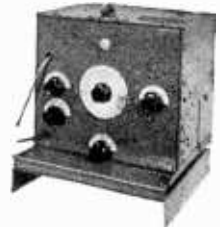

**VALVES.** American types at B.O.T. controlled retail prices for replacement purposes only. 6F6, 19F6, 19S6, 12S7, 19S7, 19E2; 1C5, 11/-; 3Z5, 11/-; 6Q7, 19Q7, 12S7, 11/7; 6K6, 6V6G, 50L6, 12/10; 6A8, 6B8, 14/-; U6 6 11/-; TDD4, 11/7; AC/VP2, EF39, KTW61, PEN 45, SP41, SP42, T41, VP41, 12/10; D1 diode 1in. Peanut valve, with valveholder, 12/10. 60S3, X63, 14/-; AC/ME, 11/-; AC6/Pen, EL35, PEN 46, VP1, 6L6, 18/3. Prices include purchase tax. Add 3d. per valve post.  
**DPDT SWITCHES.** Panel mounting ex-G.P.O., 3/-.  
**MAINS TOGGLE SWITCHES.** Panel mounting, 2/-.

### FERRANTI TEST METERS.

Complete in leather and velvet-lined case. Spec., 1,000 ohms per volt on all ranges. 600 v. A.C./D.C. 0-750 milliamps, 0-50,000 ohms, without external batteries, up to 20 megohms, with external batteries. New and unused, complete with test prods, multipliers and instructions. **£8 16s. 6d.**



# LINAGLOW LTD.

Hours of Business : Mon. to Fri. 9 a.m. to 5.30 p.m.  
Closed 1-2. Nearest Tube—Archway

◆ CALLERS to Show Rooms, 2, HIGHGATE HIGH STREET, N.6

Phone : MOUntview 9431

◆ POST ORDERS to Dept. MO 48, 61, HIGHGATE HIGH ST., N.6

Phone : MOUntview 9432

# WEBB'S *Radio*

## EDDYSTONE COMPONENTS

A preliminary range of Eddystone high-efficiency components are available for *bona-fide* maintenance work, etc.

916	Stand-off Insulators	...	...	...	1/3
999	Aerial Insulators	...	...	...	1/-
1019	Midget Stand-off Insulators	...	...	...	6d.
1018	Lead-Through Insulators	...	...	...	2/6
	6-Pin Coil Formers, Plain	...	...	...	2/9
	" " Threaded	...	...	...	3/-
1090	Former	...	...	...	6/-
964	Coil Base, 6-pin chassis	...	...	...	1/9
1094	Microdenser 5/20 mmfd.	...	...	...	5/6
1129	" 5/42 "	...	...	...	6/-
1093	" 6,62 "	...	...	...	6/6
1130	" 5/100 "	...	...	...	7/3
1131	" 160 "	...	...	...	7/6
1044	Pointer Knob, small, 1 1/2 in. long	...	...	...	6d.
1027	" " small, 2.3, 16th long	...	...	...	1/-
1076	Instrument Knob, 2 1/2 in. dia., brass insert	...	...	...	2/6
1089	Instrument Knob, 1 1/2 in. "	...	...	...	1/9
2426P	Skirt Knob, overall dia. of flange, 1 1/2 in.	...	...	...	1/6
978	Air Dielectric Trimmer, pre-set, 5/60 mmfd.	...	...	...	5/-
1013	Air Dielectric Trimmer, as 978, with 1/2 in. spindle	...	...	...	5/6
339	Split Stator Condr., butterfly wing type	...	...	...	12/6
1010	H.F. Choke, 1.25 m/h., 5/180 metres, 50 mA.	...	...	...	2/-
1022	H.F. Choke, 1.5 m/h., Tx type, 250mA	...	...	...	3/-
1011	UHF Choke, 2.5 to 12 metres	...	...	...	1/6
1066	All-Wave Choke, 17.9 m.h., 12.5 to 2,000 metres	...	...	...	2/9
1009	Flexible Coupler, insulated	...	...	...	2/6

The above components are mostly types already familiar to the discriminating engineer; new EDDYSTONE designs will fulfil modern development needs in VHF and miniature equipment. Watch advertisements for advance information on new equipment embracing all S.W. communication requirements.

### WEBB'S

stock all makes of good communication gear.

Send 2½d. stamp for

WEBB'S "INTERIM" CATALOGUE.

14 Soho Street, Oxford Street,  
London, W.1

Telephone: Gerrard 2089

We are available 9 a.m. till 6 p.m. for OFFICIAL business, but please note our revised SHOP HOURS—9 a.m. to 5 p.m. weekdays. (Saturdays 9 a.m. to 1 p.m.)

consult us on your

# PLASTIC PROBLEMS

**COSMOCORD LTD · ENFIELD**

# OKERIN WAXES

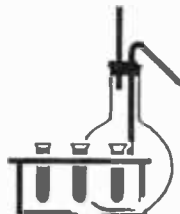

AS technical specialists in Waxes, our Research Department is at your disposal. Do not hesitate to consult us. Our Waxes are used and recommended for Service components.

A.I.D. AND C.I.E.M.E. TYPE APPROVED  
FOR  
ARCTIC AND TROPICAL CONDITIONS  
**ASTOR, BOISSELIER  
& LAWRENCE LTD.**

Sales Department:  
NORFOLK HOUSE, NORFOLK ST., STRAND, LONDON, W.C.2  
Telephone: TEMple Bar 5927



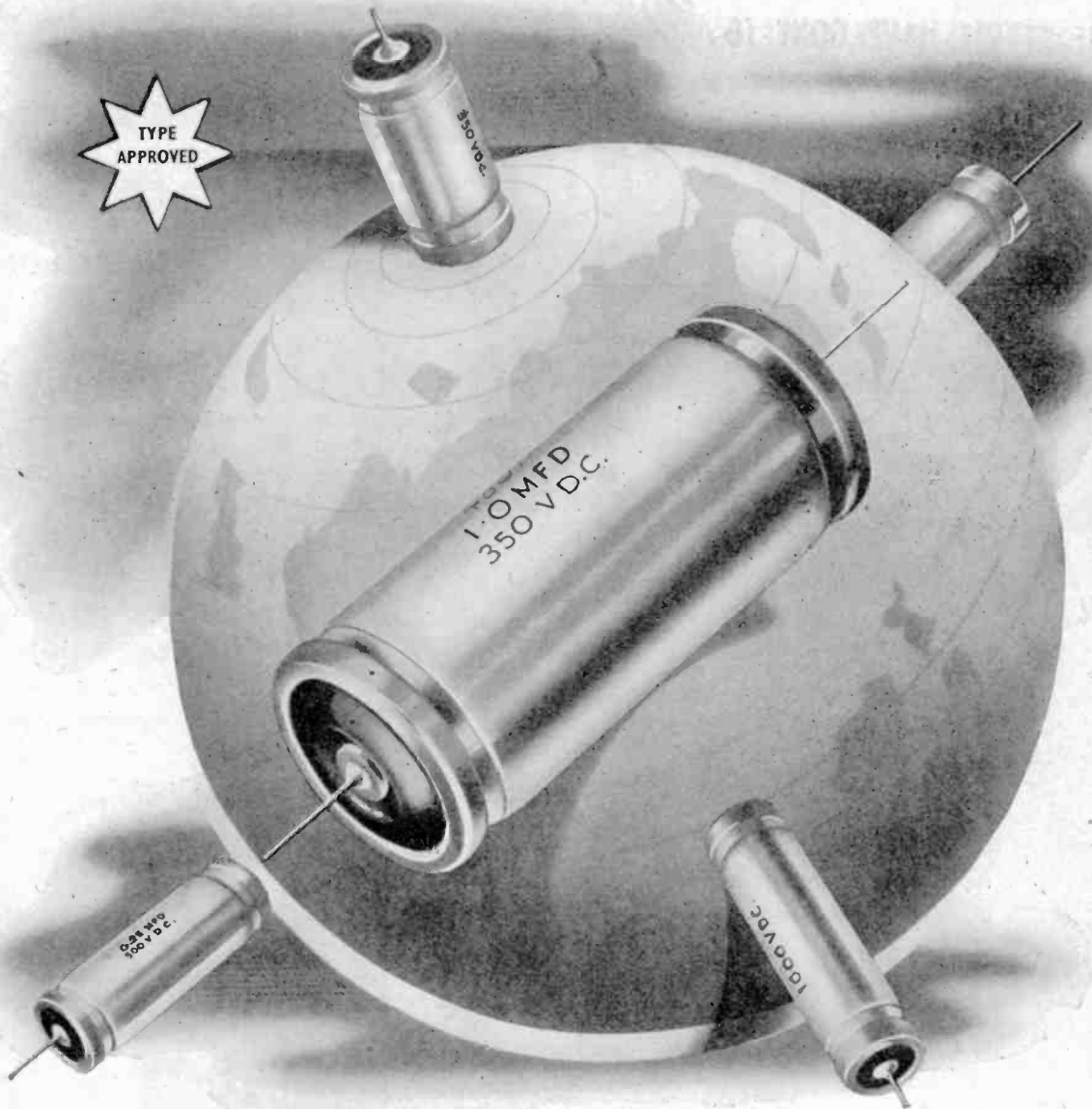

From 100° in the shade to 40° below. Dubilier Type 4800 series metal-cased Tubular Paper Capacitors are made to stand up to the most stringent operative conditions of extremes in temperature. The elements are enclosed in seamless close grained metal tubes. These Dubilier Capacitors are what is meant by the catch-phrase "tough". Unaffected by extremes of temperature, excessive humidity or high altitudes — they are essential wherever such arduous conditions are anticipated.



*The name is . . . Dubilier*

THE EXPERTS HAVE GONE TO *War*

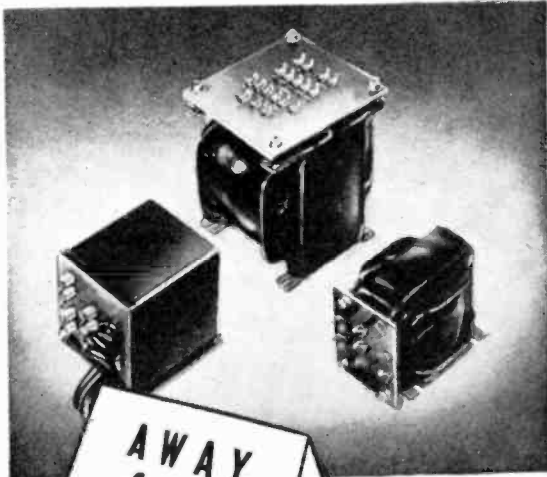

1009

**AWAY  
for the  
DURATION**

*It* is no mean achievement, even in these days of urgent priorities, to be able to say that *all* the skill of one's engineers is entirely devoted to the war effort . . . all one's output is scheduled for work of the utmost importance. But that is how it is with us at Gardners. And who can blame us if we are a little proud that our experience and skill is recognized to such an extent. And yet for all this, if you have a problem on Transformers where you think we could be of assistance to you we'll gladly co-operate to the fullest extent we can.

**GARDNERS  
RADIO LIMITED**

*Makers of Very Good Transformers*

SOMERFORD · CHRISTCHURCH · HANTS  
Tel: Christchurch 1025 Grams: Radiotrans, Christchurch



1041

... but the R.S. "UNIVERSAL FIFTEEN" is **TRULY PORTABLE**

The need for really efficient portable public address equipment was never more urgent than it is today. And when a truly portable outfit such as the R.S. "Universal Fifteen" is available—although only in limited quantities—putting up with unconnected unwieldy equipment is not only unnecessary but uneconomic. The "Universal Fifteen" operates efficiently on either A.C. or D.C. mains at all voltages from 200-250. We will gladly send you fullest details on request.



*R.S. Amplifiers*

R.S. AMPLIFIERS LTD · 2-4 HIGHFIELD RD · SHEPPERTON · MIDDX.  
TELEPHONE · WALTON-ON-THAMES · 1019

FAMOUS FASTENERS

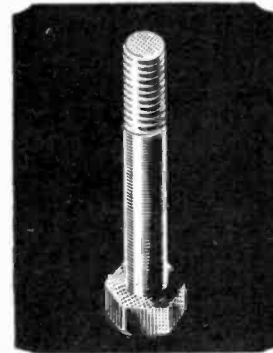

HIGH TENSILE HEXAGON BOLT

Three distinct tests ensure the standard of Linread Bolts. The first is checking of raw material, the second is specialised Quality Control during manufacture, and the third, inspection of finished products. Specialists in Cold Forging; Roll Threaded Screws; Solid and Tubular Rivets; Nuts and Bolts in all metals; Small Pressings; Auto and Capstan-turned Parts.  
LINREAD LTD., STIRLING WORKS, COX ST., BIRMINGHAM, 3.  
TELEPHONE No.: CEN. 3951 P.B.X.  
TELEGRAMS: "LINREAD BIRMINGHAM."  
London Office: Clifton House, Euston Road, London, N.W.1.  
Tele. No.: Euston 8261.



# ELECTRONICS

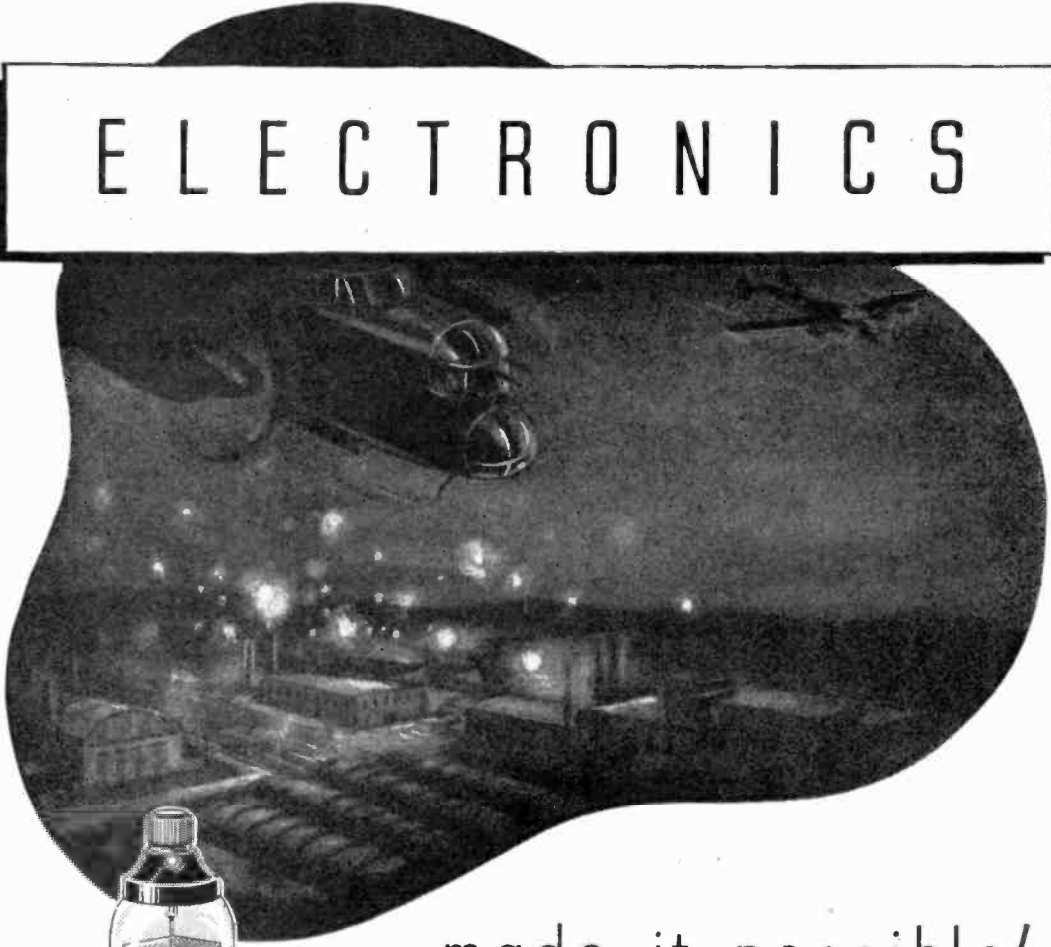

A typical OSRAM photo cell type CMGB, with many peace-time applications

made it possible!

*Hullo skipper, flares gone*—and the aircraft climbs away setting course for base, its reconnaissance pictures safely locked in the automatic camera. For the white-hot brilliance of the bursting flares operated a tiny OSRAM photo cell which automatically actuated the camera mechanism, permanently recording the panorama below.

OSRAM valves have been in the forefront of electronic development during the war, and will bring to the pursuits of peace many well tried electronic devices to speed, smooth and make safer our way of life.

**Osram**

PHOTO CELLS

**G.E.C.**

CATHODE RAY TUBES

**Osram  
Valves**

# RULE OF THUMB...



In communications, wherever measurement for testing purposes is involved, empiricism can be ruled out. Of no avail without scientific instruments is anything the eye can see, the hand feel or the most observant remember. The radio engineer, therefore, must have test gear on which he can rely and, thanks to the foresight of Marconi Instruments Ltd., has a wide selection from which to choose. And he finds exemplified in these Marconi products the qualities so characteristic of British Engineering craftsmanship—rational design, precise workmanship and technical efficiency.

## MARCONI INSTRUMENTS, LTD

ST. ALBANS, HERTFORDSHIRE

Telephone : St. Albans 4323-6

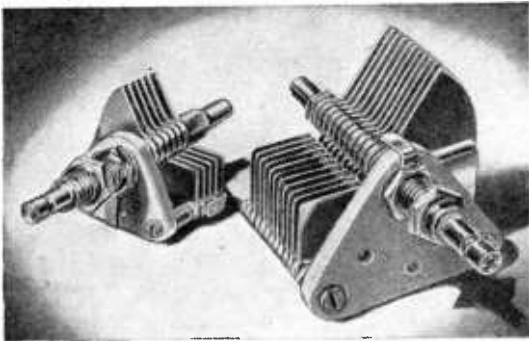

### MICRO-VARIABLE CONDENSERS

We can give immediate delivery of our standard (VCX) and Midget (MCX) models.

Type	Max. Cap in mmfd.	Min. Cap in mmfd.	Price
VC15X...	15	2.5	2/6
VC40X...	40	2.75	2/10
VC100X...	100	3.8	3/5
VC160X...	160	6.0	4 2
VC250X...	250	7.3	5/-
VC20D...	20	4.0	3/-
MC15X...	135	3.0	2 8
MC60X...	58	3.0	2 8
MC120X...	124	8.0	3 6
MC5DX...	5	3.0	2 6
MC15DX...	15	5.0	2 8

Write for details of Raymart Coils, Formers and Valveholders

Telephone :  
Midland  
3254.

**RAYMART**  
CRAFT A CREED

Please add post-  
age on orders  
valued 5,- or less

48, HOLLOWAY HEAD, BIRMINGHAM, I.

1073



## VISION...

The ability to think ahead and to appreciate the problems of others is innate at Woden, and is visibly evidenced in our own productions as well as in those components we are privileged to build for other manufacturers. If therefore you are looking ahead and would welcome intelligent co-operation in the production of your new or redesigned projects we would like to hear from you.

## WODEN TRANSFORMER COMPANY LTD

TRANSFORMERS · AMPLIFIERS · LOUDSPEAKERS  
RADIO AND ELECTRONIC COMPONENTS  
MOXLEY ROAD · BILSTON · STAFFS  
TELEPHONE: BILSTON 41959



## one in a thousand

Ten years ago we introduced the first British-made low-loss ceramic. To-day the range of FREQUENTITE components covers more than a thousand pieces of every shape and size.

With such a store of manufacturing experience we are able to offer advice backed by practical knowledge on your insulation problem. Please consult us before you finalize your design.



## STEATITE & PORCELAIN PRODUCTS LTD.

Head Office: Stourport-on-Severn, Worcs.

Telephone: Stourport 111.

Telegrams: Steatint, Stourport.

S.P.26

How much can you condense a condenser

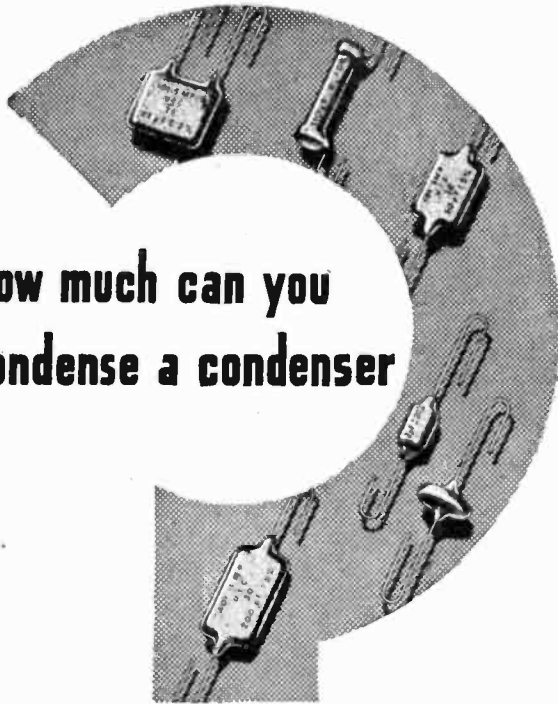

## Midget Condensers

Midgets in size but giants in performance are these U.I.C. Miniature Condensers. Especially suitable for use in the latest Service type miniature radio transmitters and receivers, they are efficient and dependable under all climatic conditions. Made to specification K.110. Type approved. Full details on request.

**UNITED INSULATOR CO. LTD.**

12-22 LAYSTALL ST., LONDON, E.C.1

Tel: TERminus 7383 (5 lines) Grams: Calanel, Smith, London

THE PIONEERS OF LOW-LOSS CERAMICS

**HEWLETT - PACKARD  
LABORATORY  
INSTRUMENTS**

FOR SPEED AND ACCURACY

**ELECTRONIC ENGINEERING  
SERVICES LIMITED**

24 Stanley Road Heaton Moor  
Stockport

SOLE BRITISH DISTRIBUTORS

*Constant Voltage*

**TRANSFORMERS**

LINE VOLTAGE VARIATIONS UP TO  $\pm 15\%$  REDUCED TO  $\pm 1\%$

Input Voltage ... 100-250 V. 50 c.p.s.

Output Voltage ... 250 V  $\pm 1\%$

Max. load ... 150 watts

Input power factor: over 90%

Price on application. Write for details.

**ADVANCE COMPONENTS LTD.**

BACK RD. SHERNHALL ST. WALTHAMSTOW. E17. PH04E-PARKSWOOD 4366Z

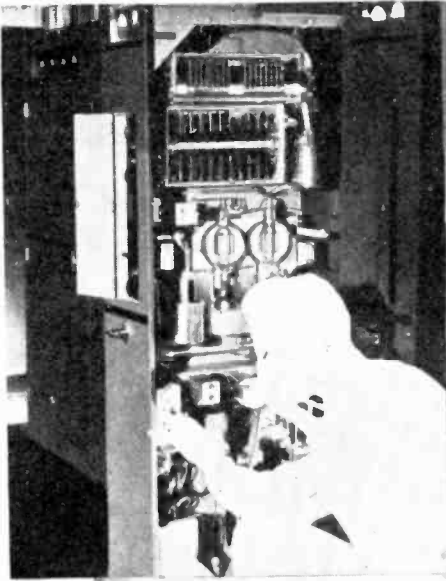

AACS Domestic Station showing a pair of Eimac 450-T valves

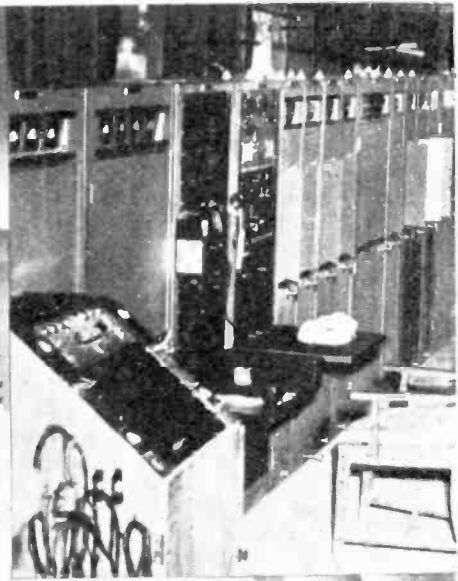

AACS Ground Station China-Burma-India Theatre

## AACS\* BLAZES THE TRAIL FOR SAFE FUTURE WORLD AIR TRANSPORTATION

World-wide aviation communications are an established fact today. Almost overnight a great radio network has been created. The actual physical difficulties involved were great enough to say nothing of the variety of extreme operating conditions encountered and overcome. Needless to say, the equipment employed must be dependable, both from a standpoint of construction and performance capability.

The establishment of radio ground stations on every continent and in fifty-two different countries...overcoming the widest extremes in operating and climatic conditions (from 40 degrees below zero to 140 degrees above)...stations in jungles...in deserts...in mountains and towns...and to have these stations constantly operating at near peak levels is a tribute to the equipment employed. On this page are shown three AACS Stations located at widely separated spots on the globe.

AACS Station on an island in South Pacific

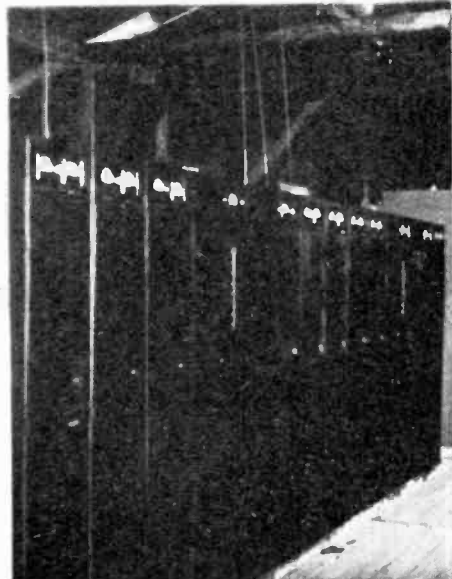

FOLLOW THE LEADERS TO



Get your copy of Electronic Teletax... the sixty-four page booklet which gives the fundamentals of electronics. This little booklet will help electronic engineers explain the subject to laymen. It's yours for the asking... no cost or obligation. Available in English and Spanish languages.

EITEL-McCULLOUGH, INC., 1030 San Mateo Ave., San Bruno, Calif.  
Plants located at: San Bruno, California and Salt Lake City, Utah  
Export Agents: Frazor & Hansen  
301 Clay Street, San Francisco 11, California, U. S. A.

\*A. A. C. S. (Army Airways Communications System)

Authorised Distributors:  
BERRY'S (SHORT-WAVE) LTD., 25 HIGH HOLBORN, LONDON, W. C.1

From 1939 to 1945  
**115,000,000**  
**RECTIFIER ELEMENTS,**  
 built into millions of rectifier units

for War Service on land, sea, and in the air—in every theatre of war as well as in every branch of war industry itself—served the needs of war to further the aims of peace.

Most of these have been of new and advanced design and the benefits of this progressive research and development will soon be made available to a!

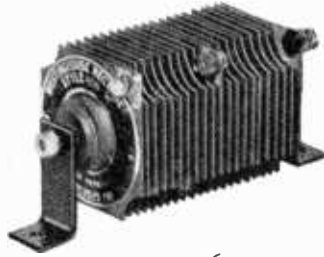

**METAL RECTIFIERS**  
 WESTINGHOUSE BRAKE & SIGNAL CO., LTD.,  
 Pew Hill House, Chippenham, Wilts.

**MINIATURE or MIDGET**

We specialise in their manufacture

**HIVAC**  
 THE SCIENTIFIC VALVE  
 BRITISH MADE

Originators, designers & manufacturers of Midget Valves

HIVAC LIMITED, Greenhill Crescent, Harrow on the Hill, Middx. Phone **HARROW 0893**

PERSONALITY  
 by  
**P. A.**



THE DIFFERENCE THE MIKE MAKES

War - shortage of sensitive micro-phones has caused mass - murder of "personality" over many workshop sound-systems. Even the works-manager's voice giving staff-talks has been unrecognisable. But now Grampian are able to release again the Grampian Pressure Microphone Type M.C.S., there is no longer any excuse for poor "local" transmissions. Replace the war-emergency "mikes" you have been using in any P.A. systems you maintain with the high-sensitivity Grampian Type M.C.S., and get rid of one of your worst sources of trouble.



GRAMPIAN MICROPHONE TYPE M.C.S. Pressure operated. Swivel stand-adaptor. Frequency 70-8000c. Impedance 20 ohms. Sensitivity 42 d.b. PRICE **£7.5**

**GRAMPIAN**  
 LOUDSPEAKERS

GRAMPIAN SPEAKER Projector Type PVH. Unit Max. Loading 10 watts. Impedance 15 ohms. Horn, length 42 in., diam. 24 in. Cut off, 170 C. P. S. PRICE **£13.5**

GRAMPIAN REPRODUCERS LTD., Hampton Road, Hanworth, Middlesex. Phone : Feltham 2657

Scientific G.6A

**Remember-Walter**

RADIO RADIO RADIO  
**STAMPINGS • CHASSIS • PRESSINGS**

FARM LANE, FULHAM, S.W.6. TELEPHONE : FULHAM 5234

C.B.C.4

**5 mmf/ft**

NEW LOW LEVELS in capacity and attenuation of CO-AX Cables mean new possibilities in electronic equipment design both for the war effort and for the post-war electronic age.

**BASICALLY BETTER AIR-SPACED**

**CO-AX LOW LOSS CABLES**  
 TRANSRADIO LTD. 16 THE HIGHWAY BEAconsFIELD 4-BUCKS.



# Announcing Glass Seal Terminals

(Process Patent applied for)

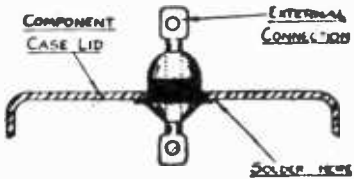

LIST No. 576

750 V. DC. Working at 40,000 feet.  
1,500 V. DC. Working at sea level.

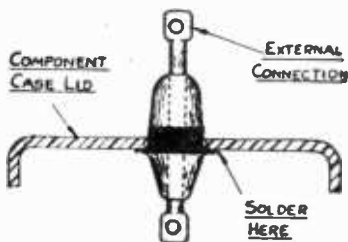

LIST No. 577

1,500 V. DC. Working at 40,000 feet.  
3,000 V. DC. Working at sea level.

AFTER rather more difficulties than we expected, we have developed a method of production in our factory at Enfield, where we are able to turn out many thousands per week.

Terminals at present available are illustrated about actual size; other sizes will follow.

They withstand instantaneous and repeated thermal shocks of at least 250°C. and will support at least 40 lbs. per square inch air pressure without leakage. These terminals are supplied tin-plated to permit soldering with modern resin cored solders or solder pastes.

Supplied packed in  
cartons containing 100.

**BELLING & LEE LTD**  
CAMBRIDGE ARTERIAL ROAD, ENFIELD, MIDDX

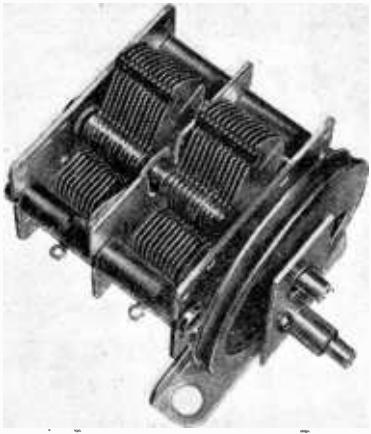

**M.G.R.N. 1, 2 or 3 GANG CONDENSER**

This is made in various capacities up to 540mmf. of Rigid construction, with smooth slow motion drive and with tropical finish. The Spindle is tapped 6 BA for attachment of pointer. An indicator can be driven by cord from the drum disc. Built in trimmers can be supplied if required.



**JACKSON**

**BROS (LONDON) LIMITED**  
KINGSWAY · WADDON · SURREY  
TELEPHONE · TELEGRAMS · WALFILCO.  
CROYDON 2754-5 PHONE. LONDON

**M.R. SUPPLIES**

continue to satisfy their many customers with the highest quality RADIO AND ELECTRICAL MATERIAL—all brand-new goods unless otherwise stated. Instant delivery (or collection from this address). All prices nett.

**LOUD-SPEAKERS.** New Vitavox high-fidelity models with Ticonal high-flux magnet, 12in. dia., 15 ohms coil, K12/10 (10 watts), £7; K12/20 (20 watts), £11 (despatch either, 5/-). Special G.E.C. 10-in. Units, 4-ohms coil, with multi-transformer, 8 watts, P.M., £2.6 (desp. 2/6).

**P.A. PROJECTOR SPEAKERS** employing the latest Vitavox P.M. Moving Coil Unit (15 ohms), handling 10 watts, with 42in. all-metal expon. Horn, £10 10s. (carr. 7/6). Same Unit with 30in. all-metal square dispersive Horn (very efficient), £9 10s. (carr. 7/6). **GOODMAN OMNI-DIFFUSION SPEAKERS** with radial six-section baffles for central suspension in dance-hall or public room, fitted 20-watt 15-ohm P.M. M/col Unit, senior model 30in. diameter, second-hand, perfect (LIST £22). A few, for callers only, at £9 15s. each. **GOODMAN SPEAKER/MICROPHONE UNITS.** 3in., latest P.M., 27/6.

**HEAVY DUTY OUTPUT TRANSFORMERS** again available. Improved "W.W." specification, providing 11 ratios from 12/1 to 75/1 with centre-tap for push-pull, handling 25 watts, weight 2 1/2 lbs., 59/6 (desp. 2/-).

**ROTHERMEL PIEZO-CRYSTAL PICK-UPS,** Senior model, with black bakelite arm, 78/9; Model S.12 with channel steel arm, 75/-; **STROBOSCOPIC SPEED TESTERS** (60 c.), showing 78, 79 and 80 r.p.m. (cardboard only), 1/-; **ERICSSON HEADPHONES,** with adjustable headgear, 2,000 ohms, 25/- pair. **CLARIONETS** (Mains dropping resistance) for midget sets, fitted English 5-amp. 2-pin plug with American entry, 37/6, 44s or 66s ohms—please state which required—12/6.

**PRECISION MEASURING INSTRUMENTS,** flush mtg., 3 1/2in., first-grade in/col., 0/1 milliamp., 67/6; 0/500 micro-amps., 75/-; **PORTABLE COMBINED INSTRUMENTS,** in crash-proof bakelite case, 6 by 4 by 3 inches, with carrying handle, 1,000 ohms/volt, universal AC/DC. Readings: M.a., 0/1, 0/10, 0/100, 0/500. Volts, 0/10, 0/50, 0/100, 0/500. Ohms, 0/5,000. Complete with cell, £8 17s. 6d.

**SWITCH-BANKS** (Trot.). Each has four banks and each bank has five 2-pole change-over switches (20 switches). On die-cast mount 3in. by 4in. Made for solenoid operation but sold as manual switches, 9/6.

**SLIDING RESISTANCES,** extremely useful range now in stock: 100-watt range, 4 ohms 5 amps., 10 ohms 3 amps., 50 ohms 1.4 amp., 100 ohms 1 amp. and 400 ohms 0.5 amp., any one 25/-; 700 ohms 0.25 amp., £1/-; 225 ohms 1 amp., 32/6; 6,000 ohms 0.25 amp., 60/-; **DIMMERS,** controlling staled load from full-bright to blackout (220/240 v.), with slow-motion worm drive and handwheel, 1,000 watts, £8 17s. 6d.; 1,500 watts, £8 8s.; 3,500 watts, £9 17s. 6d. (desp. either 7/6 and 20/- for returnable case). **RADIAL REGULATORS,** front of panel mtg., res. 1 ohm to carry 20 amps. in 25 stud taps, 77/6 (desp. 2/6). **NOTE.**—All resistances are continuously rated and are fully enclosed.

**B.T.H. ELECTRIC MOTORS,** one-third H.P., 400/440 v., 3 phase, new, £4 10s. **VOLTAGE-CHANGING TRANSFORMERS,** double-wound, 500 v.a., 230 v. to 100/110 v. (and vice versa), in cast brackets with terminal panels, 25 17s. 6d. (desp. 5/-). Also 120 v.a., 37/6 and 75 v.a., 29/6.

**ROTHERMEL-BRUSH PIEZO-CRYSTAL MICROPHONES,** Model D.104, £5 5s.; Model BR-28, sound-cell for high-fidelity studio work, £10 10s. **MINIATURE DEAF-AID INSERTS,** 1 1/2in. dia., 25/6. **G.E.C. CURRENT-FED MICROPHONES,** require no amplifier. Work direct with 15-ohms Speaker through special transformer with 12-v. accumulator. Suitable for brief announcements. With transformer, £8 10s.

Please include sufficient for despatch, where not stated.

**M.R. SUPPLIES, 68, New Oxford Street, London, W.C.1**  
(Telephone: MUSeum 2958)

WHY YOU PREFER ACOUSTICAL—One of a series

**TOPIC—Transformers**

All Acoustical Transformers are fully interleaved and conform to a high standard of workmanship and design. The output transformer for example, incorporated in the M31 Amplifier, is wound in five sections and has a frequency response from 30-12,000 cps. +0.8 db. Just one more reason why you prefer Acoustical.



"Addressing the Public"—a booklet of useful information and diagrams for all those engaged on Public Address work. 1/- post free.



**B.9.G.**

**VALVE HOLDER**

Meeting all requirements of latest specifications.

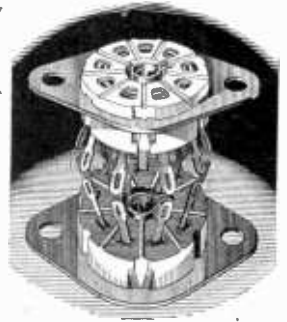

Polystyrene VH359/9. Ceramic 369/9.

**BRITISH MECHANICAL PRODUCTIONS LTD.**

1, Church Road, Leatherhead, Surrey. Tel.: 3062.



# URGENT! SAID THE G.P.O.

So Mazda Valves helped to break a bottleneck in submarine cable traffic

Beneath the Irish Sea lies a telephone cable that now carries double its peak load.

The British Post Office answered the urgent demand for greater inter-country communications by introducing a submerged Repeater into the cable which increased its simultaneous telephone circuit from 24 to 48.

Weighing nearly a ton, this repeater must give absolutely reliable service under these exacting conditions year in and year out, because to lift it from the sea-bed is a major and expensive operation.

Standard Mazda SP.41 valves were chosen for this amplifier following ageing tests on numerous different types. Checked again after 11,000 hours continuous operation, the valves were found as serviceable as ever.

Mazda are proud of their contribution to this great development in submarine cable facilities—proud of the proved reliability of their standard valve. This is but one instance of the reliable service Mazda valves are giving in many spheres where technical discoveries are hastening the birth of a new age.

## MAZDA valves

FOR INDUSTRIAL, MEDICAL, RADIO, SCIENTIFIC, TELEPHONIC AND DOMESTIC APPLICATIONS



THE EDISON SWAN ELECTRIC CO., LTD.,  
155 CHARING CROSS RD., LONDON, W.C.2.

# READY...AYE READY!

What a fine fumbling job it is, messing around with dozens of tiny nuts and washers and bolts, picking up the nut, holding the bolt with one hand while the other fiddles round the back to get the nut on the thread. And drops it! You know! Spire solves the problem. Spire U nuts slip into position over the bolt holes—no washers needed with a Spire fixing, of course. So both hands are free to put in the screws and once they're in, they're in for good. Sounds easy and it is easy!



### THAT'S Fixed THAT!

Here's a little chap in action Reference No. NU 531. Its uses are legion. Wherever there is blind assembly work, wherever your operatives are fumbling with nuts and washers the NU 531 will save time and cost and a lot of bad temper. Clip it into position and it stays "put" until you are ready to drive home the screw. No washer needed of course.

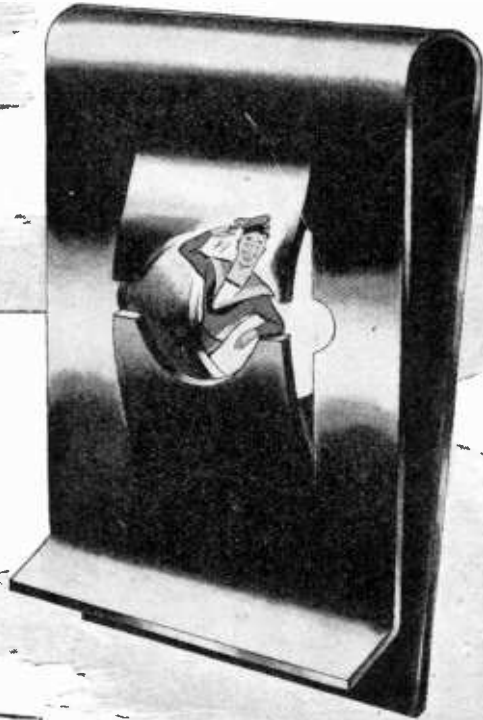

# Spire

**\* A BETTER Way of Fixing**

*Simmonds Aerocessories Limited • Great West Road • London • A Company of the Simmonds Group*

# Wireless World

Radio and Electronics

35th YEAR OF PUBLICATION

## OCTOBER 1945

Proprietors :  
ILIFFE & SONS LTD.

Managing Editor :  
HUGH S. POCOCK,  
M.I.E.E.

Editor :  
H. F. SMITH

Editorial, Advertising  
and Publishing Offices :

DORSET HOUSE,  
STAMFORD STREET,  
LONDON, S.E.1.

Telephone :  
Waterloo 3333 (35 lines).

Telegrams :  
"Ethaworld, Sedist, London."

△

PUBLISHED  
MONTHLY

Price : 1/6

(Publication date 26th  
of preceding month)

Subscription Rate :  
Home and Abroad  
20/- per annum.

MONTHLY COMMENTARY .. .. .	289
RADAR PRODUCTION .. .. .	290
AMATEUR TRANSMISSION By "Etheris" .. .. .	296
FUNDAMENTALS OF RADAR—I.. .. .	299
RANDOM RADIATIONS By "Diallist" .. .. .	303
EXTRA-TERRESTRIAL RELAYS By Arthur C. Clarke .. .. .	305
CONTRAST EXPANSION (Concluded) By J. G. White .. .. .	309
LETTERS TO THE EDITOR .. .. .	313
UNBIASED. By Free Grid .. .. .	316
WORLD OF WIRELESS .. .. .	317
RECENT INVENTIONS .. .. .	320

Branch Offices :

COVENTRY :  
8-10, Corporation Street,  
Telephone : Coventry 5210.

Telegrams :  
"Autocar, Coventry."

BIRMINGHAM :  
Guildhall Buildings,  
Navigation Street 2.

Telephone :  
Midland 2971 (5 lines).

Telegrams :  
"Autopress, Birmingham."

MANCHESTER :  
260, Deansgate, 3.

Telephone :  
Blackfriars 4412 (4 lines).

Telegrams :  
"Iliffe, Manchester."

GLASGOW :  
26n, Renfield Street, C.2.

Telephone : Central 4857.  
Telegrams : "Iliffe, Glasgow."

△

As many of the circuits and  
apparatus described in these  
pages are covered by patents,  
readers are advised, before  
making use of them, to satisfy  
themselves that they would  
not be infringing patents.

### "OVER TO YOU"

From the skies to the tanks, from H.Q. to outpost "over to you" has meant comforting contact. Maybe just a routine "fix" for the navigator or, likely as not, vital instruction for a distant patrol. Millions of times a year the "over to you" has been spoken, and millions of times Goodmans' equipment responded. In every branch of the Services Goodmans' earphones, microphones and loudspeakers, as varied in their duties as in characteristics, have played and are playing their part. In their designing and production has been builded vast new data and experience. Now with present tasks completed, this enhanced knowledge is being applied to the no less formidable needs of Peace. Now, with confidence we say "Over to you".

**GOODMANS**  
*Loudspeakers*

GOODMANS INDUSTRIES LTD. WEMBLEY, MIDD.

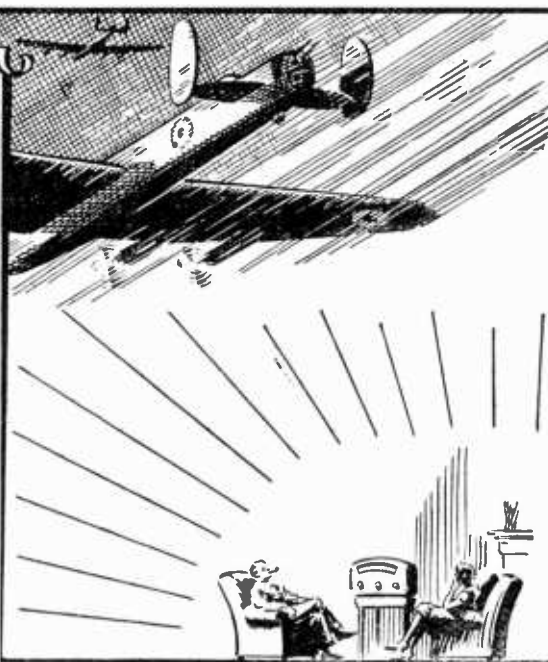

*This*  
*mathematical*  
*symbol means*  
**'not less**  
**than'**

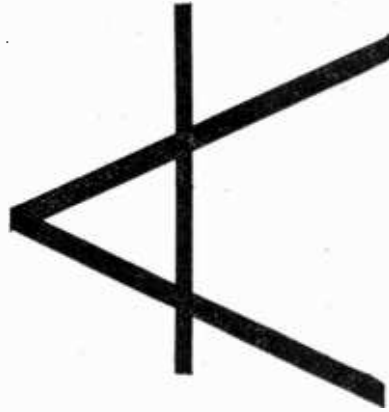

*This*  
*well-known*  
*emblem*  
*means*  
**'not less than**  
**the best'**

# PHILIPS

LAMPS · RADIO · X-RAY · COMMUNICATIONS EQUIPMENT  
AND ALLIED ELECTRICAL PRODUCTS

# Wireless World

Radio and Electronics

Vol. LI. No. 10

OCTOBER 1945.

Price 1s. 6d.

## Monthly Commentary

What is  
Radar?

IN this world of wireless we are not especially fortunate in evolving our rather peculiar jargon. It is mildly perplexing that no sooner have we been told that radiolocation or radar involves essentially the location of an object by the help of observations made on a radio wave echo reflected from that object, than we find the same term officially applied to navigational systems in which the echo plays no part. We refer, of course, to "Gee," "Oboe" and other systems which depend entirely on measurements of signal transit time; a return signal may be used in some of the systems, but it is a triggered response, and in no sense an echo.

According to the definition that *Wireless World* was officially allowed to give in 1941, the reflected radio wave is inherent in radiolocation. Similarly, Sir Edward Appleton, Secretary of the Department of Scientific and Industrial Research, (the organisation that, through its offshoot, first brought radiolocation into being) defines it as "the process of locating the position of an object in space by radio waves . . . . The only co-operation required on the part of the detected body is of a passive character, in that it is required to reflect radio waves." That certainly does not fit the signal-transit-time systems. On the other hand, signal transit time is an important or even fundamental factor in most (but not all) systems of "echo radar," as we may have to call it.

★ ★ ★

Team  
Work

TECHNICALLY speaking, the story of radiolocation is a wonderful one. No amount of familiarity with radio can blunt one's appreciation of what has been achieved

during the war years. In the wider field, the story is even more wonderful, and with a much deeper implication. To an extent that has never been known before, radar design and production has been a matter of team work; of co-ordination of the work of individuals of diverse outlook and often with mutually competitive interests. It is a new thing in the world that the principles of team

work have so fully and successfully been applied to an engineering enterprise of such diversity and magnitude.

Teams from Government research establishments, the Universities and industrial research organisations have all contributed to the solution of fundamental problems and they have been ably backed up by the productive capacity and adaptability of our industry. Sir Stafford Cripps, President of the Board of Trade, in adding his tribute to the official Government statement, quoted elsewhere in this issue, said recently, "If, as I am sure is possible, we maintain in the peace that unity of purpose and that merging of knowledge, skill and resource in the national interest which marked the British radio industry's contribution to the war effort, the industry will have a great future before it." Even more material encouragement was given in Sir Stafford's promise of support: "The Government will take all practicable steps to see that the high prestige thus established by the research and development laboratories of the British radio industry in war is maintained and by official encouragement and support is built up to even higher standards in peace. Only thus can we be sure of meeting the needs alike of national security and of the national economy."

★ ★ ★

Tuning  
Scales

ONE of the minor problems confronting the designer of broadcast receivers is the tuning scale. By common consent, the public demands a station-name scale, but in present circumstances it cannot have a reliable one. Conditions are chaotic on the broadcast bands; "channel-jumping" is not unknown and even our domestic service is on a temporary basis, and one that does not make the marking of a scale particularly easy. Early and perhaps drastic changes in channel allocation are expected in Europe. Taking everything into account, the only reasonable course seems to be to fit the clearest frequency scale that can be devised, and to hope that the lay Press will help in making the public kilocycle-conscious.

# RADAR PRODUCTION

## *Wartime Triumph of the Industry*

**S**IGNAL honour has been done to the British wireless industry. Many industries have received well-earned tributes for their contributions to the war effort, but to no other has been accorded by official Government spokesmen such unstinted praise, couched in such detailed terms, as that given to the radio industry—collectively and as individual firms—for its production of radar equipment. By now everyone knows the decisive part played in the war by that equipment, first in defence and then in offence, but it should be stressed that radar, though radio-like, is a brand-new thing, involving brand-new problems at every stage of design and production. That these problems were successfully solved reflects the highest credit on all the teams that played a part in its evolution. The work of all teams was so closely intermingled that, as Sir Stafford Cripps said at

a recent Radio Industry Council celebration, it is impossible, even if we wished, to separate the various contributions. All were partners in a new enterprise, and it shows rare qualities of flexibility of mind in the industrial teams that they were able to adapt themselves to such novel conditions.

It must not be thought that the industrial contribution was restricted to production—mere “nuts and bolts stuff.” On the contrary, much fundamental development work was done by industry. In some cases a circuit diagram, almost literally on the back of an envelope, was the basis for a “development contract,” while in others the manufacturer had to work from a crude “bread-board” prototype. An early and outstanding original contribution from industry was the “Bedford attachment” for gun-laying radar gear, evolved by L. H. Bedford,

of Cossor. Many major contributions were made by B.T.H. in producing basic radar components including thyratrons for pulse modulation. G.E.C. research laboratories played a prominent part, especially by evolving new valves, in paving the way for centimetre-wave radar.

The official story begins in the era of appeasement; it was actually early in 1937 that radar secrets were first entrusted to the industry, and contracts placed. The transmitters for the CH (Chain, Home) stations were made the responsibility of Metropolitan Vickers and the receivers were made by Cossor.

Those two firms thereby became forerunners of the many which were to work for Victory during war; but it is a matter of interest that they, together with Pye, met the heaviest proportion of wartime demands for R.A.F. ground radar stations of all kinds.

These included not only the various sets in the radiolocation chain but the ground stations associated with “Gee” (the radar navigation system), “Oboe” (the ground-controlled bombing system), “Gee-H” (another blind-bombing system).

It is, of course, impossible to indicate by name all the hundreds of contributions to the Services’ radio needs, but the airborne radar sets may be said generally to have owed their existence and production in the main to the General Electric Company (who also worked on the valves for the early radiolocation ground chain), The Gramophone Company, E. K. Cole, Bush Radio, Pye, and Cossors.

The Navy in the early days was given equally strenuous support by Allen West, of Brighton (a firm which had no previous knowledge of radio technique), British Thomson-Houston, Standard Telephones and Cables, General Electric, Pye, Marconi’s W.T. Company, Cossors, Aeronautical and General Instruments, and the Plessey Company. Cossors and The Gramophone Company largely

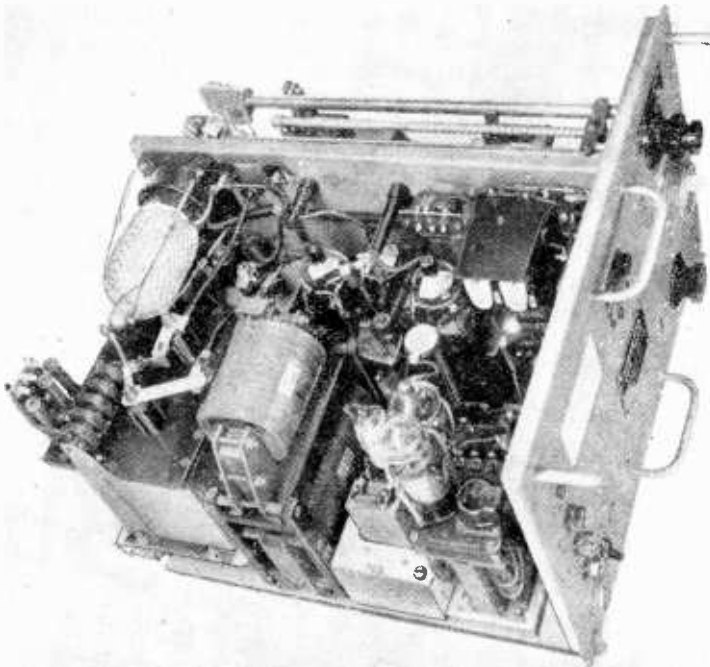

A Metro-Vick radar transmitter of the intermediate period, giving high pulse power with small valves.



served the Army's needs for GL (gun-laying) equipment for anti-aircraft batteries.

When credits are being allotted—no easy task in any one project,

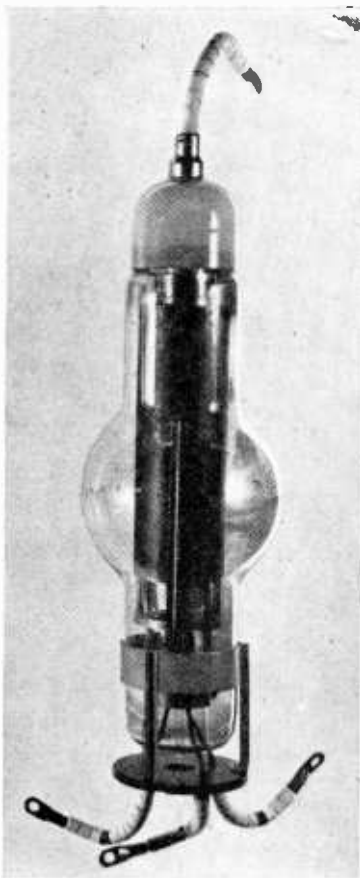

High-voltage thyatron developed by B.T.H. for use in pulse modulation.

and still less so over such a wide field as radio as a whole—it must not be forgotten that the component manufacturers alone enable the set assemblers to do their job. Such firms as the Telegraph Condenser Company, Dubilier Condenser Company, the Morgan Crucible Company, and Erie Resistor, bore a great load in the production of components.

The development of the special cables, utilising the new material Polythene introduced by Imperial Chemical Industries, was effected by the Telegraph Construction and Maintenance Company (London), who disclosed their technique to other cable manufac-

turers. These cables helped greatly to open the way to the new very short-wave techniques so essential to radar.

Mention must also be made of the smaller firms which not only met the sudden demands placed on them, but arose to eminence in the wartime radio industry in doing so. For instance, in a private house in the riverside resort of Maidenhead, the firm Dynatron Radio, Limited, undertook the production of airborne radar and other sets for the R.A.F., and achieved a position in output and quality which must be compared with the achievements of the greatest firms, some of which have already been mentioned.

When radar production first passed into the hands of industry, the chain was of vital importance, and the two contracting firms (Metro-Vick and Cossors) had to provide separate buildings for assembly and testing in complete secrecy. Two men alone were initiated into the whole story: Dr. J. M. Dodds, of Metro-Vick, and L. H. Bedford, of Cossors. Their colleagues were told only about the transmitter or the receiver; never both.

Provision of additions to this system and of the coastal defence radar for detecting enemy aircraft sowing magnetic mines were early problems of the war.

A Cambridge professor undertook a hurricane programme for the introduction along the coast of equipment which existed only in a single laboratory model. He took his ideas to the development section of Pye.

With these developments the radar defences, which were to win the Battle of Britain, were given their final link. There was, however, another non-radar link which had meanwhile been forged. This was the VHF system of radiotelephone fighter control. Three hundred equipments were hand-made by G.E.C. instrument makers at Coventry during 1938 while the production problems entailed were being solved.

The Battle of Britain began as soon as real production of airborne VHF gear was arranged, and the race was so furious that a special liaison was arranged by M.A.P. between the contractor and Fighter Command,

The ground end of VHF was just as urgent. Under the guidance of M.A.P.'s Royal Aircraft Establishment, the ground equipment was designed and built by E. K. Cole at Aylesbury and G.E.C. at Coventry. The enemy often put the ground equipments out of action during the raids on airfields, and only by working 24 hours a day could the factory workers keep the operational front intact.

One of the great production feats of the war was achieved when the Coventry G.E.C. benches and all the tools, representing about 80,000 man-hours, were almost wiped out by the enemy overnight. Plant was immediately set up at Bradford, and so speedily organised that only half a month's output was lost.

So, with radar and VHF the fighters fought and won the day battle. The night blitzes were still ahead.

From the Navy's point of view, meanwhile, the outbreak of war had not only given added impetus to the development of new devices but enormously increased the demand for standard sets for communication, and DF, in order that requisitioned vessels could be equipped.

The Admiralty Signal Establishment was rapidly and enormously expanded, partly by drawing technical talent from the very firms which were later to make so great a contribution; but no expansion could be adequate

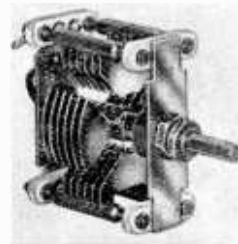

Split-stator condenser for radar developed by Eddystone. Maximum capacity (parallel-connected) 200  $\mu\text{F}$ : flash - over 700 V.

to permit adherence to the old "slow but sure" routine, and production had to be arranged before laboratory work was finished.

Outstanding among the firms

**Radar Production—**

which successfully accepted burdens thrust upon them throughout the war by the Admiralty was Allen West. This firm manufactured without working drawings, 250 early models of a radar set for detecting surfaced submarines from destroyers or corvettes.

A certain type of set was made for fitting in ships with a type of aerial which produced a narrow beam. To cope with the rolling of the ship, this aerial had to be "stabilised," making it what was at first regarded as a fantastic mechanical contraption. It was, however, successfully put into production by Ferranti, Metropolitan Vickers, and W. A. Bentley, of Leicester.

Stabilisation reminds one of gyroscopes, for which the Sperry Company of Brentford is famous. Most naval radar gear required gyro control in one form or another, for which this firm has been largely responsible.

The non-radar DF equipment used in the Battle of the Atlantic was for the main part based on receivers and other devices developed and produced by the Marconi Company at Chelmsford and the Plessey Company at Ilford, before and during the early stages of the war. In particular, the Plessey Company devised and manufactured under naval guidance an ingenious instrument which enabled a signal of very

short duration to be instantly "D/F'd," an important contribution to the defeat of the U-boat.

At the beginning of the war the first radar set, designed to provide capital ships and cruisers with long-range warning of aircraft, was being fitted; and as soon as its success had been proved, an urgent programme for sets for fitting through the Fleet was put in hand.

This first production for the Navy in 1938-1939 was undertaken by a comparatively small group of firms. Aeronautical and General Instruments, of Croydon, made the transmitters and aerial equipment, and Pye made the receiver and display panels. Aerials were also made by Hutchinson and Hollinsworth. A new type of treated, laminated wood made by the New Insulation Company of Gloucester was found to be invaluable in lessening the weight of ships' radar aerials.

Demands for an improved type of air-warning radar set made it necessary to spread production over a larger number of firms. Aeronautical and General Instruments, the Marconi Company, Pye, and Allen West assisted in producing what was at the time the most powerful radar set in existence.

At the same time a radar set suitable for small ships was urgently wanted. As a stop-gap, an Air Ministry ASV (air-to-surface-vessel) set was adapted. This was succeeded in 1941 by a more powerful naval set, the transmitter of which was made by the Marconi Company and Aeronautical and General Instruments, the receiver (a particularly good one) by Murphy Radio and the

Marconi Company; cathode-ray indicator by Ekco, and the aerial by Hutchinson and Hollinsworth.

The application of a cathode-ray tube to portray in plan the positions of all surface ships relative to each other and to the observer as if on a map of known

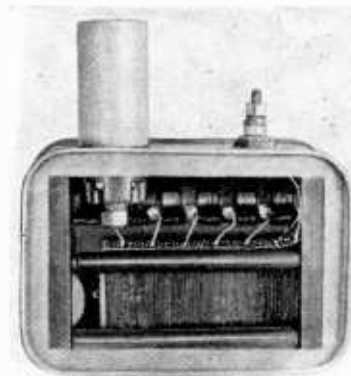

Delay-network unit for airborne HzS and ASV radar, designed to withstand high pulse loadings (case cut away). Developed and made by Dubilier.

scale was adapted for naval use by the Gramophone Company, and produced by them, Metropolitan Vickers and Allen West.

Large quantities of motor-generators and control gear were needed; Whipp and Bourne, of Rochdale, B.T.H., Newton Brothers, of Derby, and E. N. Bray, of Walthamstow, have been among the principal suppliers.

The Marconi Company produced wireless equipment of all kinds throughout the war, and this firm has contributed largely from its staff to augment the staff of Admiralty Signal Establishment. Some of the latest types of radar have been developed and constructed at Chelmsford for special naval purposes, particularly long-range air warning.

It will be appreciated that naval gunnery introduces the special circumstances in which both combatants are always moving freely in two dimensions, and, in the case of air targets, in three dimensions. Targets, too, are relatively small, and it is no use putting the shells close to them; they must be hits. This calls for extreme accuracy and first-class workmanship in instruments.

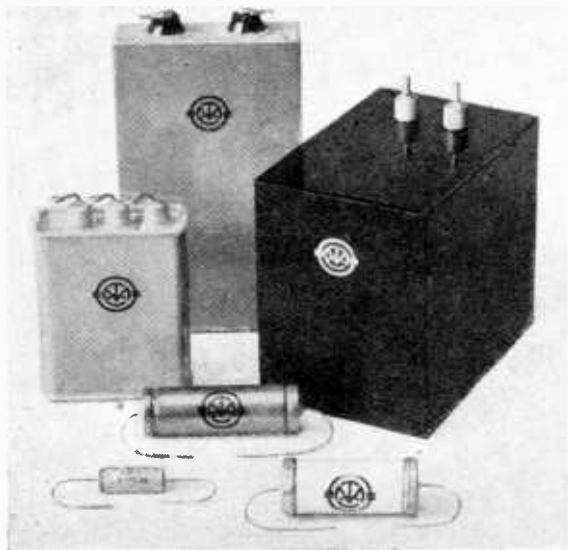

Typical TMC condensers used in radar equipment.

The first naval gun-laying set, from the radio point of view a revolutionary design, was made (with the exception of the aerials) by a number of firms experienced in radio; transmitters by the G.E.C. and B.T.H. (both at Rugby and the Willesden branch); receivers by G.E.C. and Pye; the cathode-ray indicator by Cossors, Parmeko and Ferranti.

The earlier equipments measured range only, albeit more accurately than the range-finder, yet much below the standard science knew could be achieved. Greatly improved devices measuring range, accurate to a few yards, were made from 1941 onwards by the Marconi Company and Metropolitan Vickers.

It is the beam switch which gives the direction of the target accurately, and so makes possible the "blind" firing of guns. This device requires extremely fine and accurate craftsmanship, and was

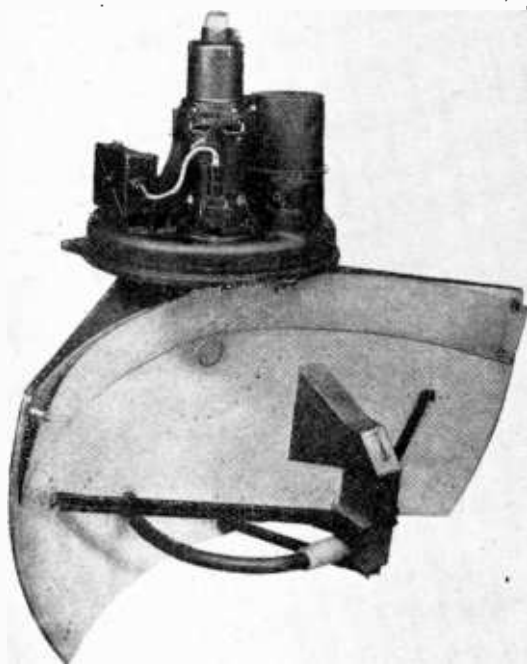

made by E. F. Moy, of Camden Town, despite all the troubles of the blitz. A very accurate yet compact form of potentiometer made by Painton, of Northampton, was also an important feature of the improved gunnery radar.

Still further changes have taken

place, making the radar set an integral part of the ship's gunnery equipment. E.M.I., the Gramophone Company, Allen West, Marconi, B.T.H. and Ferranti have all made contributions in the design and manufacture of sets which make the early types seem quite crude.

The cross-Channel radio-telephone equipment for the Navy and Army was constructed by the G.E.C. and Stratton (Eddystone), of Birmingham. The B.B.C.'s first broadcast from France after D-Day was over G.E.C. apparatus. The first cross-Channel radio conversation on D-Day was over Eddystone equipment.

An outstanding event in the preparations for the Normandy landings deserves special mention. Certain radio equipment was most urgently required for bombing operations, and similar naval demands apparently could not possibly be met in time. The Marconi W/T company, of Chelmsford, agreed to undertake this seemingly impossible task. They were introduced to McMichael Radio, who were making the gear for the R.A.F., and, starting from scratch, produced the necessary 150 sets in seven weeks, instead of a normal "war urgency" figure of at least seven months.

-----  
Scanning unit, made by Nash and Thomson, for the H2S equipment.

On land, the night blitzes were finally mastered by radar; the problem for the R.A.F. was the ground control in the dark by GCI (Ground Controlled Interception) radar stations of fighters which themselves would carry AI (Air Interception) radar to finish the chase. The Army demanded

means for the accurate sighting of AA guns and searchlights by GL (gun-laying) and SLC (Searchlight Control). GCI was a development from CHL (Chain, Home, Low-flying), and the first prototype was shown to the industry during the crucial autumn



Air-cooled Magnetron valve made by M.O. Valve Company. A pulse output of 450 kW is given at centimetric wavelengths.

of 1940. Within two months the first experimental model was ready.

This model was inspected, and at least one of the three firms concerned had its first production model installed at an R.A.F. station within three weeks. It was on the air within another six hours.

In the months during which these stations came into use the night fighters, with the Army's radar-aided searchlights and guns of AA Command co-operating, took steadily increasing toll of the enemy night bombers. In May the Germans lost 144 night bombers, of which our fighters shot down 102. Then they abandoned the raids and turned to the war on Russia.

The first AI equipment to go into fairly extensive production, consisting of four main units (the transmitter, receiver, indicator, and modulator), was ordered in August, 1940. Six hundred installations were ordered, and in September, when production was about to commence, in one of the London raids all the components and most of the piece parts for the transmitter and modulator were wiped out at Siemens' works at Woolwich.

The jigs, tools and new components were sent to the Ekco works at Malmesbury for the transmitter, and to E.M.I. for the modulator, while Pye were

**Radar Production—**

assembling the other two pieces. By working round the clock, more than 200 of the equipments had been delivered by the end of October, more than 350 by the end of the year; and 1,000 by the end of the following July, when the night blitz had already been broken.

The technique of the night fighter crews continually advanced during the war in Europe. Centimetre - wave equipment came in, and always the manufacturers were changing and adapting in a series of crash programmes the AI gear which alone made certain the detection of enemy aircraft within range at night.

The ground radar which directed the Army's defence over our coasts and cities was developed from the earliest days by Cossors and other big firms.

Metropoli-

-----  
 "Cupid" — the small radar unit mounted directly on the gun predictor and capable of selecting and following flying bombs at high speed and low altitude. Made by B.T.H.

tan Vickers received a development and construction contract for the first gun-laying equipment at the beginning of February, 1939, and the first prototype was produced in August, still before the war, with more than 400 completed by November.

On the next "mark" both Metropolitan Vickers—who were bombed on Christmas Eve but

immediately continued in a dispersal factory—and the Gramophone Company were engaged.

The design for its production was commenced by the Gramophone Company's design department in November, 1939, the basic research data having been worked out by the Ministry of Supply technicians.

An indication of the size and complexity of the equipment is



given by the fact that it weighed over a ton, incorporated no fewer than 60 valves and 122 highly accurate gears, wormwheels, cams and so on. By May the first prototype model was being field-tested and early in June was undergoing official trials, the first equipment coming off the line in November, 1940. Yet another more advanced Mark was de-

signed by B.T.H. and came off the line in February, 1943. In three months the production was at the rate of ten a week. Early models of a radar system for directing searchlights on to enemy aircraft were made by Murphy Radio in the winter of 1940-41 and produced in large quantities in 1941 and 1942.

Parallel with all the defence developments was the first of the airborne radar sets for the offensive, the ASV (air-to-surface-vessel) equipment carried by aircraft to search for shipping. Early models were produced by Ekco and Pye. The ASV which was installed in aircraft in 1939 was the first airborne radar of the war. This was followed by an improved version in a series used for finding surfaced U-boats at night. ASV was also adapted for use with the Navy in small ships for the detection of surface shipping and aircraft.

Then, owing to the desperate struggle at sea, "H<sub>2</sub>S" sets—which show coastal and other geographical outlines on the cathode-ray tubes in map form—were modified and diverted from their use by Bomber Command into coastal aircraft. This decision was taken in November, 1942, the actual production taking place in the following January and February.

With all these radar developments by no means the limit for industry had been reached. The great series of navigation and bombing aids which were to make possible the shattering of Germany's industry was on the way.

"Gee" enabled bombers to take off, assemble in saturation strength, and navigate constantly until their return, as well as making possible accurate navigation over home territory and sea in all conditions of visibility.

M.A.P.'s Telecommunications Research Establishment guided its development at Cossor's shadow factory, which was originally intended for production only, in the autumn of 1941, the firm submitting a prototype for approval in exactly six weeks. They and Dynatron shared production of the first order for 500, the smaller "daughter" firm undertaking two sets out of every five.

Their joint commitment was

more than fulfilled by February, 1942, and it has been revealed already that from that month onwards more than 2,300 acres of Germany were destroyed in a year, mainly by the use of "Gee" navigation, compared with a total of 400 acres until that system started. By the end of 1943 no fewer than 11,000 airborne "Gee" sets of an improved type—now almost universally used by Transport, Coastal, Bomber and other R.A.F. Commands as well as in naval craft—had been delivered by three big firms which were now working on it in the United Kingdom. The final achievement was a rate of production which enabled Britain to give 2,000 sets a month to her United States Allies.

During 1943 the first Mark of "Gee-H," blind-bombing aid akin to "Gee," was developed, and 200 sets delivered in three summer months.

When the battle of the Ruhr started in full blast in 1943 the "Oboe" ground-guided bombing system was introduced, principally for the pathfinders to drop their flares. "Oboe" was produced by Metropolitan Vickers, Pye, and Standard Telephone and Cables, and developed under TRE direction as a mobile unit in 1944. From the Cossor-Dynatron combination 100 airborne sets of an early "mark" were provided by August, 1943, and G.E.C. fulfilled an order for 36 of a following type by the end of November. When S.T. and C. undertook contracts for the ground end, they finished their development work in nine months.

Finally, as the world now knows, the bomber was freed from any dependence on ground radar stations. "H2S" had arrived and with it the first direct picture of the unseen earth's surface at night or in cloud.

Work on H2S went on, and within a year of the approach to industry these sets were being turned out. The technique of scanners, the revolving dish-like aerials which serve H2S (and also AI) was considerably developed at the same time, the major work going to Nash and Thompson.

The eight "boxes" which made up the original installation were developed and crash-pro-

duced by the Gramophone Company, which completed the development task hand in glove with TRE between March and December, 1942, and turned out a first order for 50 installations at the same time. By the end of April, 1944, shortly before the invasion of Europe, the total was 3,700. By the end of the European war

ate freely day or night causing no confusion in a complicated defence system, and the equipment could send out distress signals in event of trouble. This wholly British radar achievement was entrusted principally to Ferranti to develop and mass produce.

So much for the official story, which, it should be stressed,

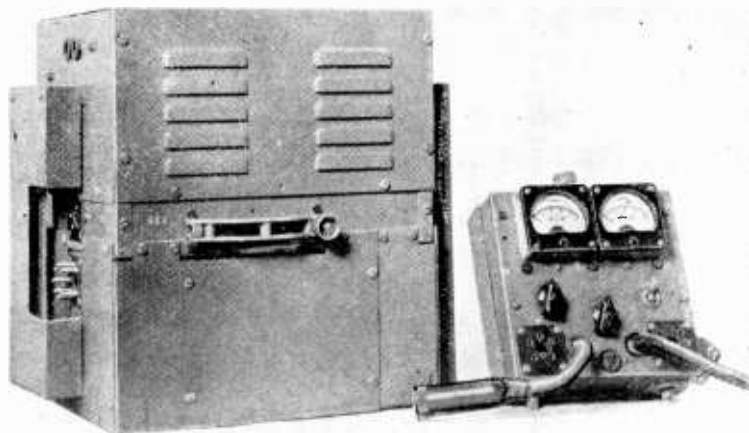

For identifying friend and foe: IFF equivalent developed and made by Ferranti.

seven out of every eight Bomber Command aircraft had H2S.

The Navy had similar needs for pin-pointing the positions of ships with the greatest accuracy to ensure the success of landings in enemy territory. While full use was made of devices already mentioned, special Naval needs were fulfilled by equipment developed by the Decca Radio and Television Company.

This story of the magnificent achievements of the radio industry, which all the time kept pace on ordinary wireless needs, can of necessity cover only a fraction of the radar devices which have been put into use. Not only are many of them still undivulged, but there are as many others whose uses for height-finding and other purposes cannot be detailed because of their very variety.

One more firm must be mentioned in another, all-pervading rôle. IFF equipment (Identification of Friend or Foe) automatically gave immediate identification of approaching friendly aircraft to radar. Allied aircraft could oper-

comes directly from British Government sources, and naturally covers the more spectacular aspects of radar. It will be obvious that much auxiliary apparatus—some of it of the highest complexity—is needed for the installation and maintenance of the equipment. For instance, it is evident that highly specialised signal generators, producing pulses of the desired length and repetition rate, are required for testing. Among the firms producing test equipment were Siemens, Erskine Laboratories and Salford Electrical Instruments. Shipton and Company was one of the makers of aerial equipment, which involves many unfamiliar problems of production. Training gear is essential if men and women are to be trained *ab initio*, and with speed and economy, in the operation of apparatus using principles seldom if ever applied before. "Trainers" were developed and made by Rediffusion and R.G.D., amongst others. But the full story of radar auxiliary gear must come later.

# AMATEUR TRANSMISSION

## Review of Past History and Future Prospects

By "ETHERIS"

**T**WO recent announcements doubtless brought hope rising in the breast of many an amateur transmitting enthusiast. They were, first, that the G.P.O. is now prepared to receive applications from pre-war transmitting amateurs for the re-issue of the radiating permits, and, secondly, that experimenters whose equipment was impounded in 1939 should now inform the Post Office where it should be returned.

Amateurs are warned, however, not to expect early restoration of either transmitting facilities or impounded equipment. Nevertheless, the above announcements, coming at the same time as the news that 10-watt valves, so largely used in amateur radio, can now be purchased without a permit, naturally lead to the conclusion that "things are moving."

No doubt they are. But enthusiasm needs to be tempered with a sober consideration of the post-war prospects of British amateur radio. Uppermost in the average amateur's mind will be the question: "What frequencies shall we get when transmitting facilities are restored?" For if he studies the uses to which in wartime his pre-war frequency bands are being put he may indeed wonder if he will get any of them back.

### Recollections

Surveying each band in turn he will recall how his 160-metre band, so useful before the war for short range cross-town working, was free of interference. According to an American authority it is now occupied by a wartime radio service which has such potentialities for peacetime use that it may well remain in that band. And how his medium-distance 84-metre band, shared with the Services before the war, is now so full of important-sounding telegraphy transmissions that he cannot see much prospect of their early removal; he will go on to recall how the 42-metre band, by far the most thickly populated

until September, 1939, is now largely occupied by broadcasting. If he listens on the old "DX band" of 14 Mc/s. he will find comparative quiet, mainly because skip effects prevent reception of the numerous commercial stations operating there. As for the bands from 28 Mc/s. upwards he will, should he listen there, experience all sorts of queer noises that sound as though they were fixed there for the rest of time!

A depressing outlook? Possibly. Yet he may take comfort if he thinks on a little further.

### Frequency Allocations

First of all, as every transmitting amateur knows, negotiations on post-war licences have been proceeding for a considerable time between the R.S.G.B. and the Post Office. The result of them can only be partially revealed as yet. For one thing it is rather too early to talk in public about frequency allocations, but the few hints dropped are so far encouraging.

A second reason for optimism is that a great deal of work is being done by official committees in the U.S.A. (and probably in the U.K. too) on the question of post-war frequency allocations for all services. Not only is the restoration of most of the pre-war amateur bands recommended by the Federal Communications Commission but mention has also been made of the possibility of an allocation in the 21 Mc/s. band and allocations of frequencies above 200 Mc/s., where propagation work on a hitherto little used part of the spectrum could be usefully done. In other words, the claims of the amateurs for a place in the post-war world are by no means being ignored.

All this spadework being done in Britain and America should greatly facilitate the submission of these claims to the international telecommunications conference,

which must inevitably be held to consider the various bids for frequencies. Very probably, such a conference would not meet for some months to come and in this event amateurs might as well abandon forthwith any hope of getting "on the air" immediately. Nevertheless an important reservation may be made here; if one or more ultra-short-wave bands could be vacated by any Government services happening to use them in Europe, they might well be re-allotted to the British amateur for use in the near future. As such bands possess optical range characteristics there could be no question of interference with other services outside the confines of this country.

Now, the ordinary broadcast listener who has never shared the enthusiasms of the transmitting experimenter may ask the question: "Why give the amateurs any frequencies at all? Before the war they didn't seem to be a very intelligent crowd of people, at least that is the impression I got listening to them on 42 metres on Sunday mornings. Surely there must be more essential services that could make better use of the frequencies?" This is, of course, a very pertinent question and one which may be paraphrased thus. Has the amateur transmitter any real value?

Many years ago at one of the early international telecommunications conferences, one delegation answered this question by suggesting that there was really no need for amateurs to transmit at all. They could do all they wanted to do on an artificial aerial. The delegation was the Japanese one, so perhaps this suggestion need not detain us further!

### Experimental Work

Then what is the real value of amateur radio?

In the past any serious-minded experimenter who wished to transmit could generally expect a sympathetic hearing from the

G.P.O. (the signs are that this attitude still remains). For in the early days of radio much of the research was fostered and brought to fruition by amateur experimenters.

As this work can now be done so much better by the great commercial companies, original research by individuals is largely a thing of the past. Yet there is every reason why experimental transmission should be encouraged as a matter of post-war policy. The man who "has radio in the blood," and who experiments because he likes to and not because he has to is of great value to the community. Individually, he may

last war. These same factors constitute the short answer to the question; what is the real value of amateur radio?

But our friend the ordinary broadcast listener is still not convinced. He sticks to his allegation that a great deal of nonsense was transmitted on the amateur bands in peacetime, and this he finds hard to reconcile with the statement that serious experimenting went on as well. In certain respects he is correct. For it must be confessed that some of the recruits to amateur radio between 1936 and 1939 did not compare in quality with the older hands. To a certain extent this

as one confessed to the writer. Amateurs with more integrity called them "baby broadcasters," an alliterative term of contempt that was well merited. Many of them dared not forsake telephony and employ telegraphy; amateur W/T procedure was a closed book to them and they simply did not know how to start.

This was not amateur experimental transmission. In the post-war world of amateur radio there will be no room for it. Consideration of a few facts and figures will make the reasons plain.

### Post-war Increases

Present portents are that Britain's 4,000 pre-war "hams" will double their numbers in a year or two after re-licensing commences. The R.S.G.B. membership, now approaching the 10,000 mark, includes many B.R.S.

The well-arranged amateur transmitting station G6GR operated, pre-war, by E. L. Gardiner, recently elected President of the R.S.G.B. A considerable amount of original research was carried out at this station on UHF. D/F., before the war.

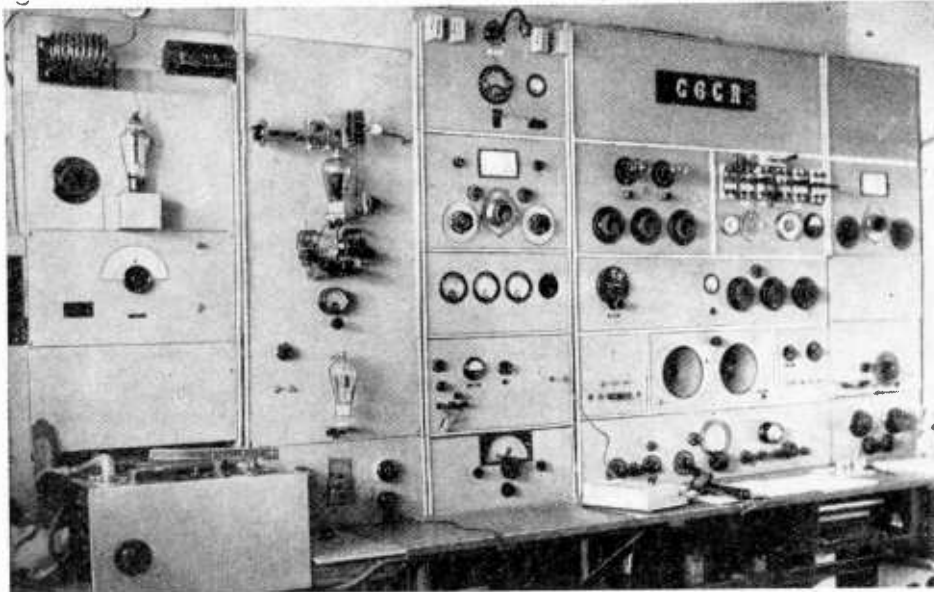

achieve little. Collectively, he and his fellow enthusiasts are indispensable cogs in the wheel of British radio industry. In wartime he is as a volunteer a far better signals-man than the "pressed man," and requires far less training. A strong amateur transmitting community comprises a reserve of ready-to-use operators, as was actually shown in 1939. And the list of transmitting amateurs who hold senior commissioned rank in the Services is indeed impressive. These are factors that will undoubtedly influence the British Government to restore transmitting facilities as soon as conditions allow, as was actually their policy after the

was inevitable. Transmitting permits were being issued at a rapid rate in the three years before the war, and though the percentage of black sheep may have remained small, the total in numbers grew. And it was they who, being the most vocal, discredited amateur radio by their inane telephony transmissions on the 7 Mc/s band on Sunday mornings.

Those with more money than sense were able to buy ready-made transmitting stations which they frequently operated at far more than their licensed power. They and many others scraped through their G.P.O. morse test and then with a sigh forgot it all,

(British Receiving Station) members who, learning of amateur radio during the war, will want to savour it more fully afterwards. The Americans are expecting their 50,000 amateurs also to double themselves in a few years. A *pro rata* increase may be expected in all other countries where wartime radio and radar have brought many new enthusiasts into contact with electronic applications.

Before the war amateur transmitters collectively outnumbered all the "professional" stations put together. After the war they will probably do so to an even greater extent. Being authorised by their Governments to transmit, they might well expect those same

### Amateur Transmission—

Governments to find some more frequencies for them as their numbers expand. But it is not the amateur's way to agitate for more ether-room. He is content if, after each successive international telecommunications conference, he is left with that which he held before. His hope is that he gets back the majority of his pre-war bands, and should the proposed 21 Mc/s band come to him he would indeed be perennially grateful.

Therefore, assuming that double his pre-war numbers are to be accommodated in the same bands as before, the most intense interference ever known may be confidently expected. And then the extinction of amateur radio by suffocation caused by its own dead weight would almost surely follow. Greater discipline will need to be imposed on the amateur bands than was shown before the war. In those days, all right-thinking amateurs, while condemning the follies of the frivolous or inconsiderate minority, possessed no means of preventing them. Though 90 per cent. of the occupants of any band might be well disciplined the other 10 per cent. could spoil the value of the band for everyone else.

### Disciplined Operating

It would seem that the necessary discipline will have to be imposed by legislation operating somewhat on the following lines:

The higher-frequency half of each band might be reserved for telephony. There was a trend in this direction before the war. But in one of the most important bands of all (14 Mc/s) a curious anomaly existed. The central 100 kc/s were occupied by U.S. amateur "phones," with the result that the rest of the world's "phones" were compelled to transmit outside the American 'phone band if they were to make themselves heard at all in the U.S. or elsewhere.

This meant that they occupied frequencies normally employed for CW. The whole arrangement was unsatisfactory for telephony and telegraphy operators alike. Obviously, future 'phone bands will need allocating on a multi-lateral basis among the nations, and not unilaterally as happened in

America. Further to reduce interference between "phones," a limit of five minutes might be set to a single telephony transmission; in that period ten times the amount of matter can be transmitted by microphone than by key. The humming and hawing garrulity of the pre-war 'phone operator will be quite uneconomic on the congested post-war bands. The telephony enthusiast may argue that his type of emission needs more ether-space than half of any band. It happens, however, that CW stations have always greatly outnumbered "phones," and a half-and-half basis is a fair one.

Scope exists for the telephony enthusiast to double his frequency allocation by adopting single sideband working or carrier suppression. The telegraphy enthusiast may argue that there is no case for telephony and the B.B.C. do it better anyway. The answer to this is (a) that properly used, telephony will dispose of traffic at ten times the rate of a hand-keyed CW transmitter, and (b) that telephony equipment de-

other bands the use of a new beam aerial may double field strength for a given input, and abuse of power may then be more apparent than real.

Where it is suspected international legislation should permit licensing authorities not merely to inspect a station but actually to search the premises for illicit sources of power. In such cases a mere warning or suspension of facilities should be supplemented by a stiff fine.

### Operating Ability

Finally, there is the question of operating ability. No amateur may transmit before passing the G.P.O. morse test. But as already stated, he may "with a sigh forget it all." Proficiency in operating by telegraphy could be fostered by three-yearly morse tests by the Post Office, except where an amateur belonged to a Service wireless reserve and had obtained a certificate of morse proficiency, renewable every three years. A test of operating ability need not be agreed internationally, and in

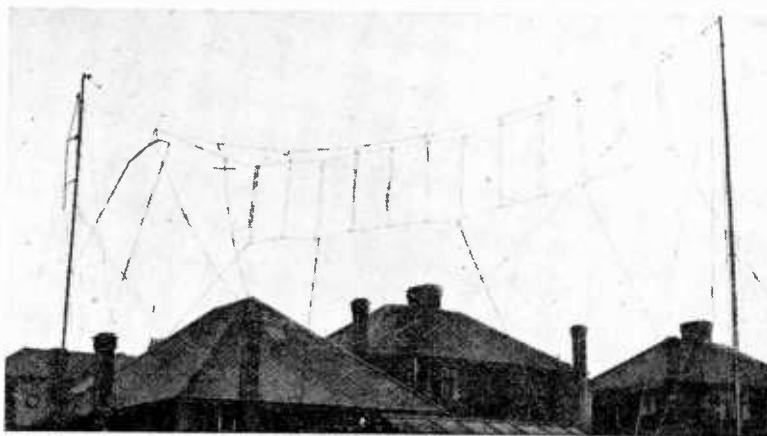

An imposing UHF aerial array as used by H. A. M. Clark at his station G60T for investigating wave propagation on the very high frequencies.

mands considerable skill in construction and operation (forgetting the complete stations that can be bought over the counter!) and long distance working is more difficult to achieve than with telegraphy sets.

On certain bands where skip effects are negligible an unauthorised use of power is frequently apparent to listeners familiar with the normal signal strength of a given station. On

the case of British amateurs could be made one of the conditions for the retention of the G.P.O. permit.

Regulations based approximately on the proposals in the three foregoing paragraphs should do much to assist efficient operating in the post-war bands, and to permit amateurs truly to live up to their official status of holders of "experimental wireless transmitting permits."



# FUNDAMENTALS OF RADAR

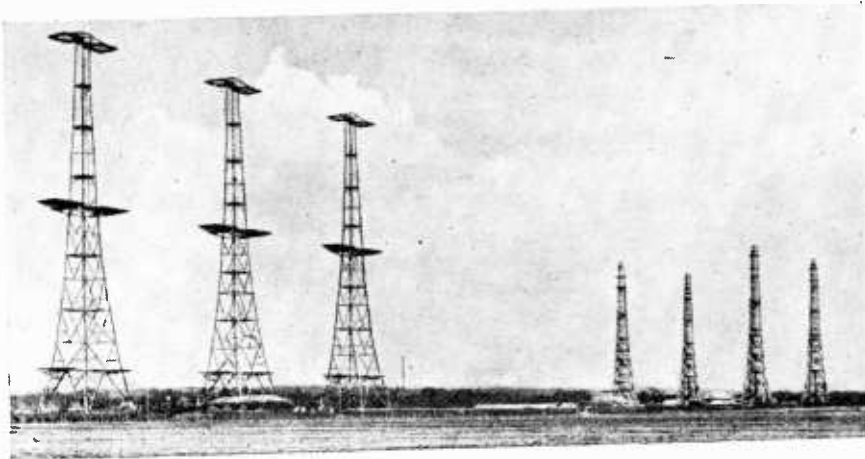

## 1. Ground Stations: The Development of Pulse Technique

**I**N *Wireless World* for February and March, 1945, Dr. Smith-Rose discussed the basic principles and history of radar. It was not permissible, at that time, to discuss more than the broadest outlines; now, with the end of the war, details may be given of the instruments used.

The radar story begins with the "Chain, Home." This was the first operational radar system and led by logical steps which were determined by the war situation to the host of devices which are now available. In December, 1935, five operational stations were established on the east coast of England, and in August, 1937, fifteen additional stations were authorised to cover the east and south coasts of Great Britain. More were being set up at the beginning of the war, and with the fall of France CH coverage was extended round the south-west and west coast. The design of these stations was a peacetime design, and was very dependent on existing techniques. The wavelength used was 10 to 13 metres and pulses of about 10 to 15 microseconds duration were radiated at a recurrence rate of 25 pulses per second. The nominal pulse power was initially 200 kW, but later developments brought it up to about 800 kW. As the transmitter was "marking" only for 250 micro-

seconds in each second, the mean power was only  $\frac{1}{4}$  kW when the pulse power had reached 800 kW. This very small mark/space ratio is characteristic of radar transmitters and explains the very high pulse powers which have been obtained.

The aerial systems of the CH stations were fairly conventional. The transmitting array consisted of stacks of horizontal dipoles and reflectors slung from 350ft. towers; the receiving aerial system comprised a pair of crossed horizontal dipoles for direction-finding and two dipoles at different heights for elevation measurement. The receiving aerials were mounted on a 240ft. wooden tower. The whole transmitting system was not very different in fundamentals from a telegraph transmitter and array, while the receiver with its goniometer for direction finding follows normally from ordinary Bellini-Tosi or Adcock practice. The CH transmitter floodlit the area in front of it, so that any aircraft in that area was "illuminated" by the radiation. Scattered energy came back to the receiver and was handled by the direction finder in the familiar way.

General view of transmitting and receiving aerials at a CH station is reproduced at the top of this page.

To determine the height of the aircraft, the angle of arrival of the echo in the vertical plane was measured. This was done, as was mentioned above, by using two horizontal dipoles at different heights. In Fig. 2 portions of the polar diagrams for the two aerials are shown.

As would be expected, an aircraft at a small angle of elevation is received more strongly by aerial (2) than by aerial (1). The ratio of the strengths is related to the actual angle of elevation, and when this ratio has been measured by comparing the two signals with a goniometer, the height can be read off from a calibration chart. At a range of 150 miles and a height of 12,000ft. the angle of elevation is only about one degree (neglecting the curvature of the earth) so that only the first lobe need be considered.

The time interval between the transmitted pulse and the received pulse gave the range. Aircraft could be detected at ranges of up to 200 miles, and once detected they could be kept under continuous observation.

The disadvantages of the CH stations must have been realised even before they were built. Radiation which leaked back inland produced echoes from hills and from aircraft outside the zone of interest. Height-finding by the

**Fundamentals of Radar—** use of the polar diagram of elevated dipoles is unsatisfactory, and frequent calibrations were necessary. Crossed horizontal di-

CHL stations described below, when mounted on towers, had a  $h/\lambda$  value of about 45. With the huge box-like formations used for day raids in the

The CHL stations ("Chain, Home, Low") were devised. A wavelength of 1.5 metres was chosen. Transmitters capable of producing pulse powers of over 100 kW were designed and gave ranges exceeding 100 miles. A major change was also made in the method of radiating and receiving the pulses. At a wavelength of 1.5 metres it is quite practicable to produce a sharp beam with an aerial array of moderate dimensions. The actual array used was about four wavelengths by five.

The size of the array is expressed in wavelengths because it is known that the width of the beam produced by an aerial array is proportional to  $\lambda/l$ ; that is, it is inversely proportional to the dimension of the array in the plane under consideration. An array 10 wavelengths wide produces a beam twice as sharp as an array 5 wavelengths wide. A beam which fell to a sharp minimum at 10 degrees off the main radiation axis in the horizontal plane was produced. The whole structure was small enough to be turned continuously, so that the effect was rather that of a lighthouse. As the beam swept round it lit up a narrow section of the sky: any aircraft in that sector scattered radiation back towards the station. It was obviously desirable to use a beamed receiving aerial system to increase the sensitivity: such a receiving beam must be kept accurately in step with the transmitting beam so that the receiver is watching the "bright" part of the sky. A very ingenious arrangement was adopted. The transmitter requires the use of the aerial system for only a few microseconds at a time; then, for the next millisecond or so, the transmitter is dead and the aerial system can

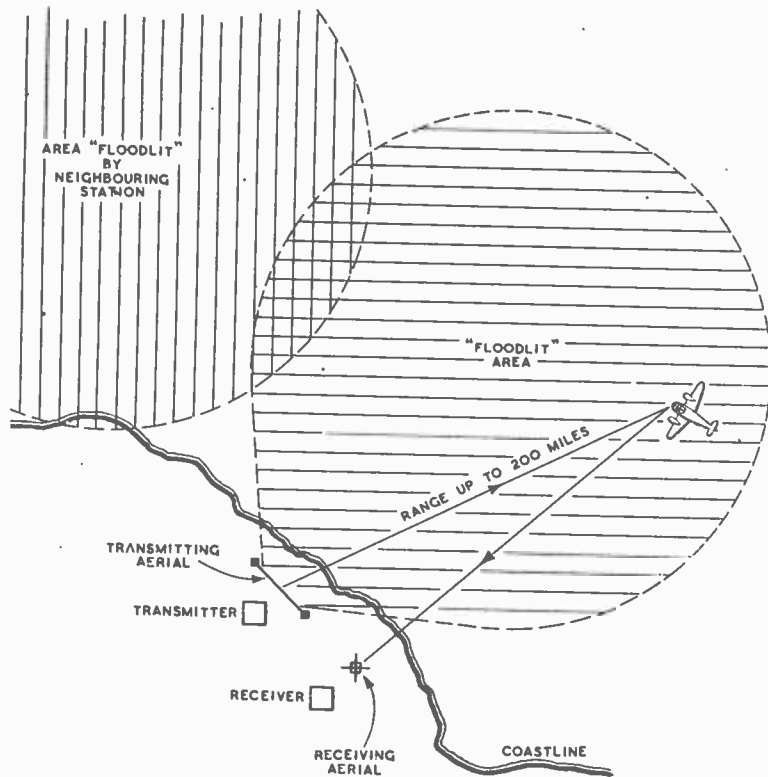

Fig. 1. "Floodlighting" and direction finding by Chain, Home Stations.

poles are liable to polarisation error in direction finding and frequent calibrations to check the balance of the system were needed. Above all, however, the mean height of the aerial system was only about 200 feet, and it was found that low-flying aircraft could not be detected except at short ranges.

This was because the aerial polar diagram, produced in the usual way by the aerial system itself and its image in the earth, has a minimum along the surface of the sea. The first maximum, which is the most useful region, is at an angle of elevation inversely proportional to the height of the aerial measured in wavelengths, that is to say, proportional to  $\lambda/h$ . To provide a very low pick-up it is necessary to raise the aerial as high as possible and to make the wavelength as short as possible. The CH stations had a  $h/\lambda$  value of about 8. The

summer of 1940 this was not important, but it was clear that sooner or later low-level raids would be attempted to prevent radar warning being given. It is at this stage that the real radar story begins, and that development moved away from conventional practice.

For both coastal artillery range-finding and for protection against low-flying aircraft it was necessary to use shorter wavelengths.

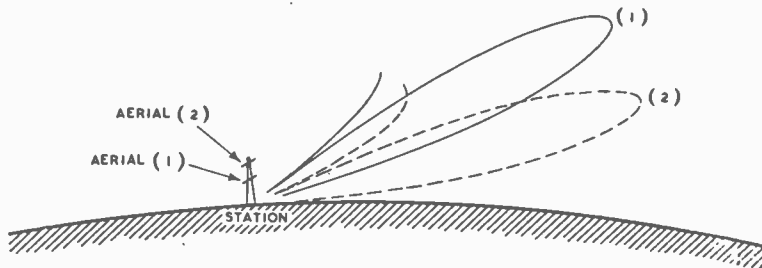

Fig. 2. Vertical polar diagrams of elevated dipoles at a CH station.

be used for reception. It is necessary to provide a protective device which will prevent the transmitted pulse being passed straight to the receiver.

A technique using this idea had already been developed for ionospheric work, but a more

tion in the CHL equipment. In a PPI the time base has its origin at the centre of the tube, and the spot travels radially outwards. The radius along which it travels is parallel to the searchlight beam of the radiation, and as the aerial array rotates so does the time

pencil. Further discussion of displays will be given later.

The arrival of a "direct appreciation" display enabled the CHL system to be used for fighter control direct from the cathode-ray tube without the intervention of the plotters who moved coloured plaques about on a map—the arrangement used in the handling of CH information. The equipment was known as GCI (Ground Controlled Interception) and was an elaborated form of CHL in which a pair of arrays of different height provided measurement of the angle of elevation and thus of the height of the aircraft.

When the CHL stations came into service there remained only a blind zone of a few hundred feet above the sea. To deal with wave-hopping coastal raiders, and to watch the movements of shipping, a further step down in wavelength was made.

The latest systems using centimetre waves and large reflectors enable very sharp beams to be produced which are largely independent of the proximity of the ground or sea. Very clear PPI pictures are obtained.

Before continuing further with



Rotating beam arrays used at CHL stations. The 185-ft. tower is used at sea level and the 20-ft. gantry shown on the right is for installation on cliffs.

Fig. 3. (Below) Rotating beam at a CHL station.

efficient system for use on fixed frequencies was devised, and this will be described later.

With the introduction of beamed transmission and reception came also a new form of "display" or indication on the receiver CR tube. The CH stations used a normal horizontal time base which was deflected by the reflected pulse in the way described by Smith-Rose. The goniometer used for direction-finding and elevation enabled the signals from two aerials to be compared or balanced. The "Plan Position Indicator" was introduced to display the informa-

base. Received pulses are used to brighten the spot. A target thus produces a bright spot of light at a distance and in a direction from the centre of the tube which corresponds directly to the distance and direction of the target from the aerial system. The operator thus gets a direct physical picture of the position of the target without any manipulation of controls. If a map is drawn on the face of the tube, the picture is even easier to follow, and the track of an aircraft can be followed by marking its position at intervals on the glass tube with a "chinagraph"

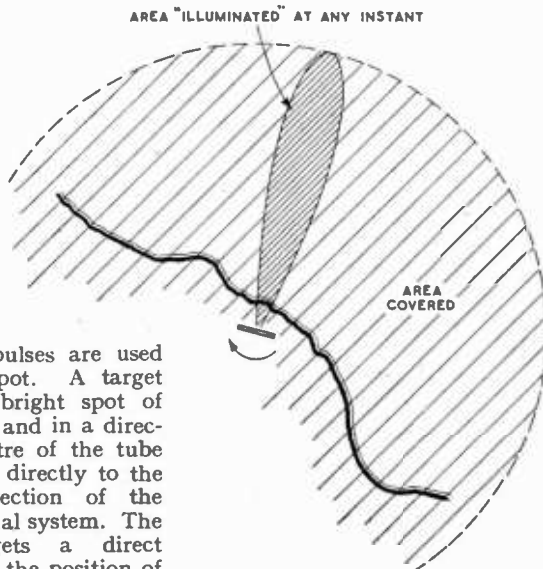

the discussion of radar equipment there are some important fundamental ideas which must be considered.

#### Pulse Repetition Rate

The CH stations emitted only 25 pulses per second. The reason

**Fundamentals of Radar—**

for this is that although aircraft are not normally detected at ranges greater than about 200 miles, there is sometimes sufficient return by normal ionospheric

factor in the choice of repetition rate.

**Pulse Width**

In the discussion of pulse repetition rate above we have seen that

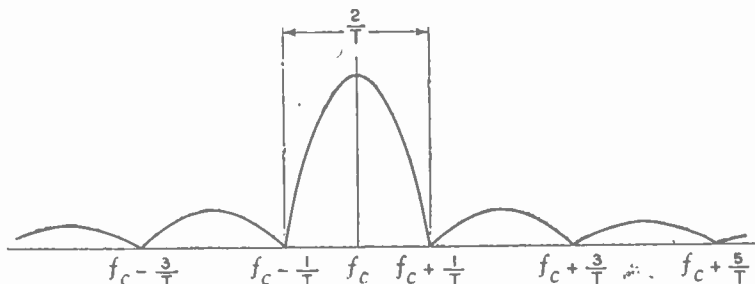

Fig 4. Sideband structure of rectangular pulse of length  $T$ .

scattering to give echoes with delays of up to 40 milliseconds, corresponding to distances of the order of 4,000 miles. This scattering is believed to be due to ionic clouds in the E layer. When this happens it is essential that the scatter from one pulse should not appear after the transmission of the succeeding pulse, or a false short range reflection would be simulated. At shorter wavelengths ionospheric effects cease to be of importance, and the pulse repetition rate can be increased. The limitation on repetition rate is always set by the maximum range from which an echo can be received. If the maximum working range of the equipment is 186 miles, the repetition rate may not exceed 500 pulses per second. Even though the operational range required may be less, it is the actual range which sets this limit, and if a high repetition rate is required it may be necessary to reduce the working range by reducing the transmitter power or the receiver sensitivity.

Another point to be considered in settling the repetition rate is the power dissipation. As the repetition rate rises, so does the mark/space ratio. With 25 ten-microsecond pulses per second the ratio is  $1/4,000$ ; with 2,500 one-microsecond pulses per second the ratio is  $1/400$ . If the peak power is the same, the mean power, and in consequence the heat dissipated in the valves, is increased by a factor of 10. In centimetre equipments this is often the limiting

narrow pulses permit higher peak powers for the same energy dissipation. Furthermore, as a 10-microsecond pulse corresponds to a range of about one mile, it is difficult to resolve two targets which are at nearly the same range, as the two echoes overlap. Targets within a mile of the station cannot easily be detected. Shorter pulses give better resolution and more accurate range measurement. Obviously it is useless to radiate very short pulses unless they can be received. A pulse of duration time  $T$  consists of a carrier and a continuous set of sidebands; most of the energy lies in a bandwidth of about  $2/T$ . Thus a one-microsecond pulse re-

quires a bandwidth of at least two megacycles, while a 10-microsecond pulse needs only 200 kc/s. If a one-microsecond pulse is used it is therefore necessary to provide a receiver with a pass-band at least two megacycles wide: otherwise energy is being radiated in sidebands which cannot be received and is being wasted. The noise level at the receiver is also dependent on bandwidth, and in early systems like CH, where sensitivity was more important than resolution or accuracy, long pulses and narrow bandwidths were used. As radar developed from being a warning device it became necessary to provide more and better information, and shorter pulses and wider bands were introduced. It is interesting to note that with a communications receiver provided with a bandsread dial the main peak and two peaks on each side shown in Fig. 4 could easily be separated. In this way a good estimate of the pulse length used was made, by measuring the spacing of the minima.

**Sweeping Rate**

In radar systems which use a beamed transmission it is necessary to consider the relation between the pulse repetition rate and the rate at which the beam is moved. Assume that the transmitter sends out 400 pulses per second, as a CHL transmitter does, and that most of the energy

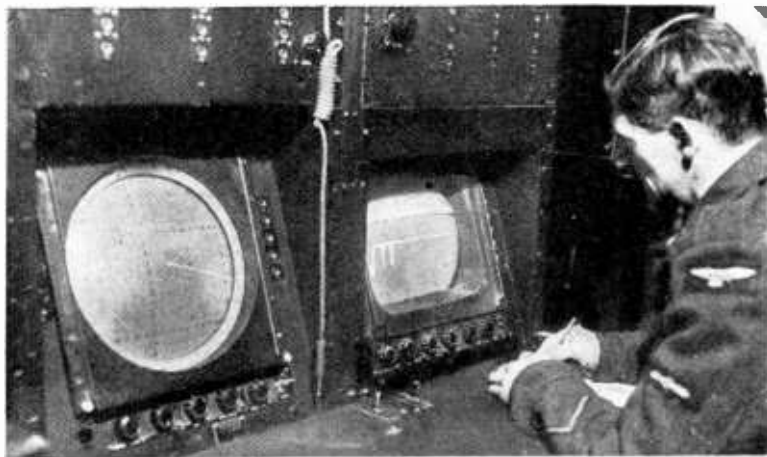

Two forms of display are used at GCI stations. The PPI (Plan Position Indicator) with rotating radial time base is on the left and the range scale with linear time base on the right.

is concentrated within 5 degrees on either side of the line of shoot. If during the 2.5 milliseconds which has been allowed, in choosing the repetition rate, for the return of an echo, the aerial array has turned through more than 10 degrees, the array will not receive the echo. Therefore an angular velocity of 4,000 degrees per second will cause complete failure of the system. Of course, this is about 600 revolutions per minute, and no one who has seen a CHL array would doubt that this speed is quite impossible. Another factor, however, brings the limiting speed down. With long

afterglow cathode-ray tubes, which are used to keep a steady picture on the PPI, it is necessary to receive a number of successive echoes to "paint" the tube. If we choose 10 as a convenient requirement, our limit becomes 30 r.p.m. For the CHL, mechanical considerations keep the speed down to something of the order of 6 r.p.m., so that no difficulty is experienced. With centimetre radar, the narrower beams and smaller structures lead to the limit being set by the "build-up" time of the cathode-ray tube rather than by the difficulty of moving the aerial system.

seemed to regard the development of their own radiolocation systems as of rather secondary importance, preferring to concentrate their best scientific brains on the production of new and fearsome weapons, none of which ever quite came off.

### Very Neat

There were some pretty neat bits and pieces amongst radiolocation equipment even in the earlier days before the microwave apparatus came along. One of my favourites was the transmitter of the "GL" used in AA gunnery. It was not merely foolproof, it was pretty well blinking-idiot-proof. If Ham-handed Henry (or, later, Scatter-brained Susie) tried to switch on the HT when the cooling device for the master-oscillator and power-amplifier valve wasn't working, there was nothing doing; unless the draught of air from the blower was raising a hinged shutter and operating a mercury switch, nothing could be done about it. Nor would the HT switch work if those valves weren't getting their grid-bias. In fact, if H.H.H. or S.S. tried in a moment of madness to do almost anything that was bad for its health, this transmitter simply switched itself off and bade them think again. A delightfully simple arrangement made it possible for the operator to find out whether it was sending out a pulse of the right shape and of the right duration. The very accurate wavemeter, too, could be used successfully after a remarkably brief training period. A girl who had been, say, a dressmaker a few weeks before would report without turning a hair that the pulse was half a microsecond too "wide" or that the transmitter was "point three megacycle off tune." And a REME "Radio-Mech." (one of my best was a Scottish crofter, whose home was 40 miles from a railway station and who had never handled even the simplest electrical appliance before the war) would go and set matters right. Before the end of the war not a few radio-mechs. were girls—and a radio-mech. had to be capable of tracking down all sorts of tricky faults and of putting them right in double quick time.

□ □ □

### Clean-up Needed

THE medium-wave broadcast band is in a shocking mess just now. Running over it a few evenings before this was written, I counted thirty-odd inter-station heterodynes in addition to natural interference so bad in some cases that it amounted to something like jamming. That is bad enough, but it's not the whole of the sad tale.

## RANDOM RADIATIONS

By "DIALLIST"

### For This Relief . . .

WELL it's come at long last! The radiolocation cat is out of the security bag and one can at length speak and write freely of principles which have been common knowledge in the scientific world for a dozen years and more; you'll find the whole business of ionosphere sounding described in text books published from 1930 onwards—and the timing by means of a CRT of the delay between the sending of a short-wave wireless pulse and the return of the echo due to it is the basic principle of all radiolocation. I'm all for secrecy when and where it serves to hide from an enemy something valuable to us and unknown to him. It was very right and proper that microwave radiolocation methods and the working details of many systems should have been kept as dark as dark could be; but I never could see why things well known in all enemy countries and put to practical applications there should have been regarded as ultra hush-hush here. It was ludicrous, for example, to find two cinema films describing the cathode-ray tube and its use for measuring the height of the reflecting layers and for tracking breeding grounds of atmospherics placed in the secret category. These films were made by the N.P.L. and shown publicly at the Wireless Exhibition some years before the war! Many readers must have seen them then. In view of what we knew that our late enemies were doing in the radiolocation field a simple statement of the general principles of the art issued officially could have done no harm. On the

contrary, it would have been good and heartening war news and might have taken a form which would have led the other side to believe that we had made far less progress than was actually the case.

### It Saved Us

My own belief is that radiolocation, or rather our pre-eminence in the art, was the decisive factor in winning the war. I know from personal experience that it saved us from losing it in 1940, when Goring's gigantic *Luftwaffe* attacks were staged as a prelude to the invasion which we could hardly have hoped to repel had it been made. If we hadn't had our chain of efficient early-warning radiolocation stations, the Spitfires and Hurricanes of No. 11 Fighter Group and the guns of the Sixth A.A. Division could never have routed the hordes of the German air-arm. Pilots and gunners had little enough rest as it was; had we not known when raids were coming and what courses they were taking, they'd have been fought to a standstill through sheer physical exhaustion. We could not have brought off, later on, the mass air raids on German industry, whose effects were so decisive; we could not have tackled the submarine menace; we could not have prevented the destruction of our cities by bombers and "doodle-bugs"; we could not have held Malta; we could not have wiped out the Italian fleet so effectively and cleared the Mediterranean if we had not had radiolocation and if we had not exploited it to the utmost. Providentially for us, our enemies

### Random Radiations—

In addition to broadcasting stations, radio beacons are working on this waveband and causing a considerable amount of interference. Doubtless you have heard them, though possibly you did not realise what they were. A radio beacon sends out its call sign in slow morse, then a dash lasting many seconds; then comes an interval of a second or two and the process is repeated. The transmissions are automatic and I imagine that they are done by a wipe contact travelling over the rim of a rotating wheel carrying conducting strips of appropriate length for the dots and dashes and for the long note which follows the call sign. Whatever may have been necessary in wartime, there can be no good reason why the beacons should now operate on the already overcrowded MW band. Let us hope that the much-needed clean-up will be made soon and a satisfactory re-allocation of channels made. It should not be nearly so difficult as it was in former years to prepare a satisfactory "plan": a large part of the trouble when previous plans were made was that Germany and Italy had grabbed far more than their legitimate share of channels, obviously with an eye to propaganda work before and during the war that was then to come and is now, mercifully, over. Meantime radio manufacturers must be having some headaches over deciding what to put on the tuning dials of the new receivers that they are designing.

### The RIC Scheme

The wavelength allocation scheme put out by the RIC is clearly the result of much hard work and hard thinking on the part of those who were responsible for it. Though it contains much that is good, it is to my mind open to criticism at one point; I am emphatically against an 11-kc/s separation between channels. Reasons? Here are some of them. The United States and Canada use a 10-kc/s separation which seems to have proved satisfactory, considering the vast number of stations at work in North America. Even before the war several of the more strongly received Americans were interfering after about 9 p.m. in winter time with the reception of medium-wave Europeans by causing heterodyne whistles. Many of the Americans will no doubt increase their power output in the near future and a good deal of interference with foreign listening is to be anticipated if we adopt an 11-kc/s channel separation. One of the most valuable features of the 10-kc/s separation is

that it enables channels to be numbered by the two or three figures which indicate tens of kilocycles. Thus, if the MW band extends from 1,500 to 550 kc/s, the channels are numbered 150, 149, 148 . . . 55. A tuning dial graduated in this way becomes at once intelligible to anyone, even if he doesn't know what a kilocycle is. He sees from the table of stations that the one he wants is working on Channel No. 63, or 630 kc/s. All that he has to do is to twiddle his knob till pointer is at 63 on the scale and there he is, provided, of course, that the calibration of the scale is reasonably correct. It may be objected that if American stations can heterodyne Europeans when transmitting with a carrier difference of a few kc/s, they can also jam them when using the same carrier frequency. I've never noticed anything of the kind. The field strength of transatlantic stations is so much less than that of worthwhile Europeans that the worst that happens is the production of a faint background signal during programme intervals.

### The Cabinet Question

Another little problem for the radio industry is that of the cabinets which are to house their new models. To my mind the cabinet problem is one to which a satisfactory answer has so far seldom been found. The domestic wireless set is nowadays a piece of furniture and, like other pieces of furniture, it should be pleasing to the eye in addition to fulfilling its primary purpose. Many pre-war receivers seem to owe the inspiration for the design of their cabinets to the same source as Gray's "Elegy in a Country Churchyard": tombs and tombstones were the predominating

*motif*. Others went all ultra-modern with polygons and chromium plating. Strangest of all were those weird anachronisms, the Jacobean or Queen Anne radiograms and consoles. Admittedly the cabinet designer's task is no easy one. The chassis designer demands that knobs, dial and loudspeaker fret shall be in certain positions and the cabinet must allow for this. And if he gives rein to originality, the cabinet designer may find his opposite numbers in the laboratory shaking their heads over resonant chambers and such-like. For all that, I do feel that close liaison between laboratory and studio should be able to produce radio cabinets which are neither funereal nor artful and crafty in their appearance. In the immediate future the cabinet designer may have to cut the overcoat of the set according to the cloth, in the shape of wood and plastic materials, made available by whichever of the many powers that be is responsible for the allocation of such things. Still, I don't altogether give up hope of seeing as time goes on cabinets that combine good appearance with freedom from boominess.

□ □ □

### Plus Ça Change

THE other day I dropped into a local wireless shop, hoping to be able to replenish my sadly depleted store of BA screws and nuts. My enquiry was met by a shake of the proprietor's head and the kind of twisted smile that is reserved for those who ask silly questions. "Sorry," he began. "There's a . . ." But I forestalled him. "Yes," I said; "I know what you were going to say. There's a peace on."

### Books issued in conjunction with "Wireless World"

	Net Price	By Post
FOUNDATIONS OF WIRELESS. Fourth Edition, by M. G. Scroggle . . . . .	7/6	7/10
TELEVISION RECEIVING EQUIPMENT, by W. T. Cocking . . . . .	10/6	10/10
RADIO LABORATORY HANDBOOK, by M. G. Scroggle. Second Edition . . . . .	12/6	12/11
WIRELESS SERVICING MANUAL, by W. T. Cocking. Sixth Edition . . . . .	7/6	7/10
HANDBOOK OF TECHNICAL INSTRUCTION FOR WIRELESS TELEGRAPHISTS, by H. M. Dowsett and L. E. Q. Walker. Seventh Edition . . . . .	30/-	30/7
RADIO DATA CHARTS. Third Edition, Revised by J. McG. Sowerby, B.A., Grad. I.E.E. . . . .	7/6	7/10
RADIO INTERFERENCE SUPPRESSION, by G. W. Ingram . . . . .	5/-	5/4
LEARNING MORSE. 335th thousand . . . . .	6d.	72d.
INTRODUCTION TO VALVES, by F. E. Henderson . . . . .	5/-	5/4
RADIO WAVES AND THE IONOSPHERE, by T. W. Bennington . . . . .	6/-	6/3

Obtainable from leading booksellers or by post from

LIFFE & SONS LTD., Dorset House, Stamford Street, London, S.E.1

# Angles on **BRIMAR PRESTIGE**

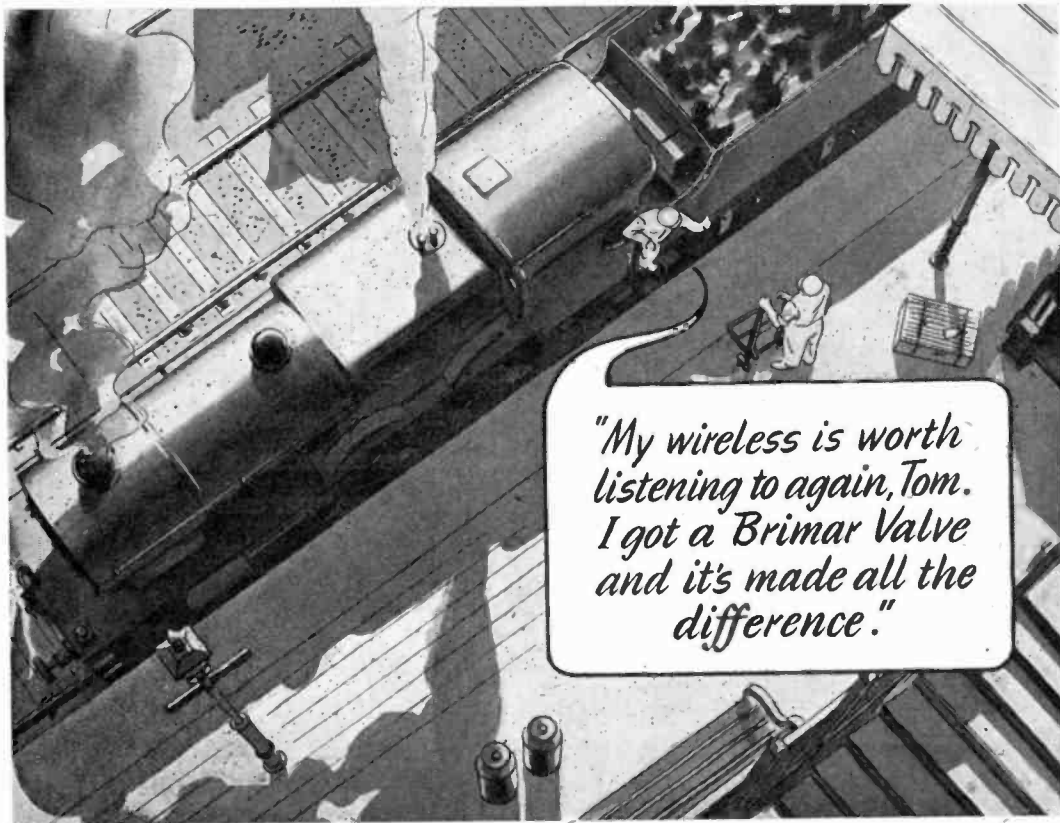

*Brimar Valves operate to very close limits with complete reliability. "Peak performance" is an automatic result of their use. Although valves are still in short supply, you may be able to get the Brimar Valve you require.*

# BRIMAR

(BVA)

# VALVES

STANDARD TELEPHONES AND CABLES LIMITED, FOOTSCRAY, SIDCUP, KENT.



The useful life  
of 5,000,000  
Television Receivers  
will depend on

## INSULATION

**DELARON**  
LAMINATED PLASTIC  
in Sheets, Panels, Strips, Tubes and Rods.

**Delaflex**  
INSULATING SLEEVING  
in Varnished Cotton, Metal Screened,  
Varnished Rayon, Rolled Silk, Woven  
Fibre Glass.

**HAMOFIL**  
CONNECTING WIRES  
and Push-Back Wires.

To the problem of the insulation of radio and electronic equipment, De La Rue Insulation Limited offers a wealth of experience and a range of insulating materials of proven worth. We will gladly send you data, samples and prices on request and the services of our Technical and Development Department are, naturally, freely available to you.

DE LA RUE INSULATION LIMITED  
IMPERIAL HOUSE • 84 REGENT STREET • LONDON • W.1 TELEPHONE: REGENT 2901

*The*

# TAYLOR A.C. BRIDGE

MODEL 110A

These instruments give quick and accurate measurements of Capacity and Resistance. There are six Capacity ranges covering from .00001 to 120 mfd. and the Power factor can also be measured on each range. Six Resistance ranges are available measuring from 1 ohm to 12 megohms. This bridge is A.C. mains operated and a leakage test is also available for detecting leaky paper or mica condensers. Price £14 14s. 0d.

Please write for technical leaflet.

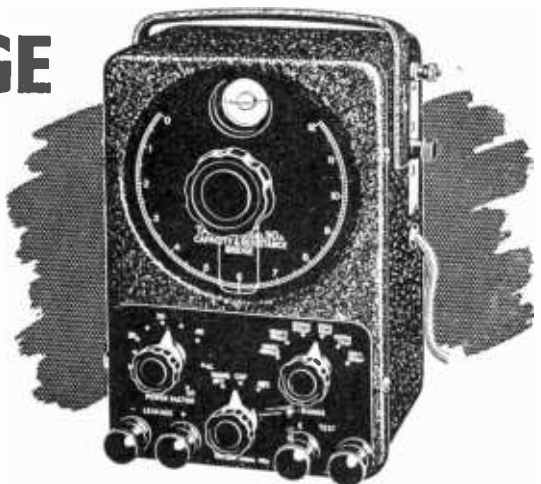

**6** RANGES OF CAPACITY  
RANGES OF RESISTANCE

Send your enquiries to:—

**TAYLOR ELECTRICAL INSTRUMENTS LTD**

419-424 MONTROSE AVE., SLOUGH, BUCKS.  
Tel: Slough 21381 (4 lines) Grams: "Taylins", Slough.

**Taylor**  
electrical instruments Ltd



# EXTRA-TERRESTRIAL RELAYS

## Can Rocket Stations Give World-wide Radio Coverage?

By ARTHUR C. CLARKE

ALTHOUGH it is possible, by a suitable choice of frequencies and routes, to provide telephony circuits between any two points or regions of the earth for a large part of the time, long-distance communication is greatly hampered by the peculiarities of the ionosphere, and there are even occasions when it may be impossible. A true broadcast service, giving constant field strength at all times over the whole globe would be invaluable, not to say indispensable, in a world society.

Unsatisfactory though the telephony and telegraph position is, that of television is far worse, since ionospheric transmission cannot be employed at all. The service area of a television station, even on a very good site, is only about a hundred miles across. To cover a small country such as Great Britain would require a network of transmitters, connected by coaxial lines, waveguides or VHF relay links. A recent theoretical study<sup>1</sup> has shown that such a system would require repeaters at intervals of fifty miles or less. A system of this kind could provide television coverage, at a very considerable cost, over the whole of a small country. It would be out of the question to provide a large continent with such a service, and only the main centres of population could be included in the network.

The problem is equally serious when an attempt is made to link television services in different parts of the globe. A relay chain several thousand miles long would cost millions, and transoceanic services would still be impossible. Similar considerations apply to the provision of wide-band frequency modulation and other services, such as high-speed facsimile which are by their nature restricted to the ultra-high-frequencies.

Many may consider the solution proposed in this discussion too far-fetched to be taken very seriously. Such an attitude is unreasonable, as everything envisaged here is a

logical extension of developments in the last ten years—in particular the perfection of the long-range rocket of which V2 was the prototype. While this article was being written, it was announced that the Germans were considering a similar project, which they believed possible within fifty to a hundred years.

Before proceeding further, it is necessary to discuss briefly certain fundamental laws of rocket propulsion and "astronautics." A rocket which achieved a sufficiently great speed in flight outside the earth's atmosphere would never return. This "orbital" velocity is 8 km per sec. (5 miles per sec), and a rocket which attained it would become an artificial satellite, circling the world for ever with no expenditure of power—a second moon, in fact.

the atmosphere and left to broadcast scientific information back to the earth. A little later, manned rockets will be able to make similar flights with sufficient excess power to break the orbit and return to earth.

There are an infinite number of possible stable orbits, circular and elliptical, in which a rocket would remain if the initial conditions were correct. The velocity of 8 km/sec. applies only to the closest possible orbit, one just outside the atmosphere, and the period of revolution would be about 90 minutes. As the radius of the orbit increases the velocity decreases, since gravity is diminishing and less centrifugal force is needed to balance it. Fig. 1 shows this graphically. The moon, of course, is a particular case and would lie on the curves of Fig. 1. if they were produced. The proposed German space-stations

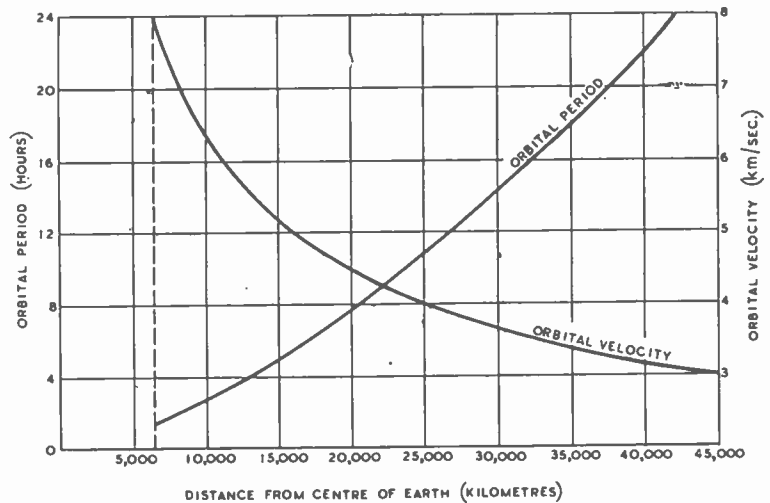

Fig. 1. Variation of orbital period and velocity with distance from the centre of the earth.

The German transatlantic rocket A10 would have reached more than half this velocity.

It will be possible in a few more years to build radio controlled rockets which can be steered into such orbits beyond the limits of

would have a period of about four and a half hours.

It will be observed that one orbit, with a radius of 42,000 km, has a period of exactly 24 hours. A body in such an orbit, if its plane coincided with that of the

**Extra-terrestrial Relays—**

earth's equator, would revolve with the earth and would thus be stationary above the same spot on the planet. It would remain fixed in the sky of a whole hemisphere and unlike all other heavenly bodies would neither rise nor set. A body in a smaller orbit would revolve more quickly than the earth and so would rise in the west, as indeed happens with the inner moon of Mars.

Using material ferried up by rockets, it would be possible to construct a "space-station" in such an orbit. The station could be provided with living quarters, laboratories and everything needed for the comfort of its crew, who would be relieved and provisioned by a regular rocket service. This project might be undertaken for purely scientific reasons as it would contribute enormously to our knowledge of astronomy, physics and meteorology. A good deal of literature has already been written on the subject.<sup>2</sup>

Although such an undertaking may seem fantastic, it requires

Fig. 2. Typical extra-terrestrial relay services. Transmission from A being relayed to point B and area C; transmission from D being relayed to whole hemisphere.

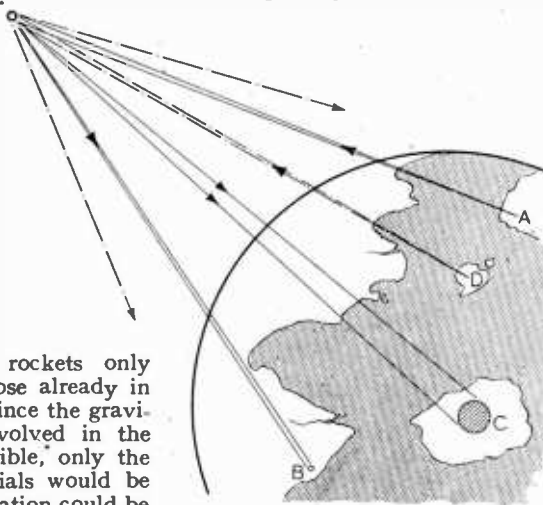

for its fulfilment rockets only twice as fast as those already in the design stage. Since the gravitational stresses involved in the structure are negligible, only the very lightest materials would be necessary and the station could be as large as required.

Let us now suppose that such a station were built in this orbit. It could be provided with receiving and transmitting equipment (the problem of power will be discussed later) and could act as a repeater to relay transmissions between any two points on the hemisphere beneath, using any frequency which will penetrate the ionosphere. If directive arrays were used, the power require-

ments would be very small, as direct line of sight transmission would be used. There is the further important point that arrays on the earth, once set up, could remain fixed indefinitely.

Moreover, a transmission received from any point on the hemisphere could be broadcast to the whole of the visible face of

necessary evidence by exploring for echoes from the moon. In the meantime we have visual evidence that frequencies at the optical end of the spectrum pass through with little absorption except at certain frequencies at which resonance effects occur. Medium high frequencies go through the E layer twice to be reflected from the F

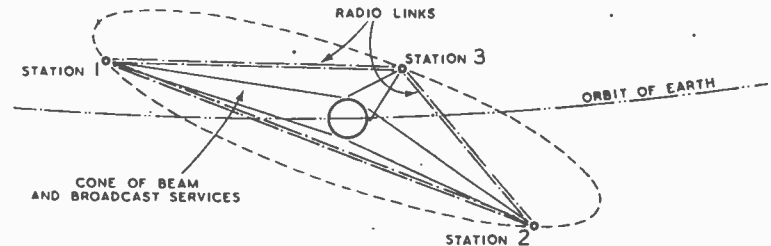

Fig. 3. Three satellite stations would ensure complete coverage of the globe.

the globe, and thus the requirements of all possible services would be met (Fig. 2).

It may be argued that we have as yet no direct evidence of radio waves passing between the surface

layer and echoes have been received from meteors in or above the F layer. It seems fairly certain that frequencies from, say, 50 Mc/s to 100,000 Mc/s could be used without undue absorption in the atmosphere or the ionosphere.

A single station could only provide coverage to half the globe, and for a world service three would be required, though more could be readily utilised. Fig. 3 shows the simplest arrangement. The stations would be arranged approximately equidistantly around the earth, and the following longitudes appear to be suitable:—

- 30 E—Africa and Europe.
- 150 E—China and Oceania.
- 90 W—The Americas.

The stations in the chain would be linked by radio or optical beams, and thus any conceivable beam or broadcast service could be provided.

The technical problems involved in the design of such stations are extremely interesting,<sup>3</sup> but only a few can be gone into here. Batteries of parabolic reflectors would be provided, of apertures depending on the frequencies employed. Assuming the use of 3,000 Mc/s. waves, mirrors about a metre. across would beam almost all the power on to the earth. Larger reflectors could be used to illuminate single countries or regions for the more restricted services, with con-

of the earth and outer space; all we can say with certainty is that the shorter wavelengths are not reflected back to the earth. Direct evidence of field strength above the earth's atmosphere could be obtained by V<sub>2</sub> rocket technique, and it is to be hoped that someone will do something about this soon as there must be quite a surplus stock somewhere! Alternatively, given sufficient transmitting power, we might obtain the

sequent economy of power. On the higher frequencies it is not difficult to produce beams less than a degree in width, and, as mentioned before, there would be no physical limitations on the size of the mirrors. (From the space station, the disc of the earth would be a little over 17 degrees across). The same mirrors could be used for many different transmissions if precautions were taken to avoid cross modulation.

It is clear from the nature of the system that the power needed will be much less than that required for any other arrangement, since all the energy radiated can be uniformly distributed over the service area, and none is wasted. An approximate estimate of the power required for the broadcast service from a single station can be made as follows:—

The field strength in the equatorial plane of a  $\lambda/2$  dipole in free space at a distance of  $d$  metres is <sup>4</sup>

$$e = 6.85 \frac{\sqrt{P}}{d} \text{ volts/metre, where}$$

$P$  is the power radiated in watts.

Taking  $d$  as 42,000 km (effectively it would be less), we have  $P = 37.6 e^2$  watts. ( $e$  now in  $\mu\text{V}/\text{metre}$ .)

If we assume  $e$  to be 50 microvolts/metre, which is the F.C.C. standard for frequency modulation,  $P$  will be 94 kW. This is the power required for a single dipole, and not an array which would

concentrate all the power on the earth. Such an array would have a gain over a simple dipole of about 80. The power required for the broadcast service would thus be about 1.2 kW.

Ridiculously small though it is, this figure is probably much too generous. Small parabolas about a foot in diameter would be used for receiving at the earth end and would give a very good signal/noise ratio. There would be very little interference, partly because of the frequency used and partly because the mirrors would be pointing towards the sky which could contain no other source of signal. A field strength of 10 microvolts/metre might well be ample, and this would require a transmitter output of only 50 watts.

When it is remembered that these figures relate to the broadcast service, the efficiency of the system will be realised. The point-to-point beam transmissions might need powers of only 10 watts or so. These figures, of course, would need correction for ionospheric and atmospheric absorption, but that would be quite small over most of the band. The slight falling off in field strength due to this cause towards the edge of the service area could be readily corrected by a non-uniform radiator.

The efficiency of the system is strikingly revealed when we consider that the London Television

service required about 3 kW average power for an area less than fifty miles in radius.<sup>5</sup>

A second fundamental problem is the provision of electrical energy to run the large number of transmitters required for the different services. In space beyond the atmosphere, a square metre normal to the solar radiation intercepts 1.35 kW of energy.<sup>6</sup> Solar engines have already been devised for terrestrial use and are an economic proposition in tropical countries. They employ mirrors to concentrate sunlight on the boiler of a low-pressure steam engine. Although this arrangement is not very efficient it could be made much more so in space where the operating components are in a vacuum, the radiation is intense and continuous, and the low-temperature end of the cycle could be not far from absolute zero. Thermo-electric and photo-electric developments may make it possible to utilise the solar energy more directly.

Though there is no limit to the size of the mirrors that could be built, one fifty metres in radius would intercept over 10,000 kW and at least a quarter of this energy should be available for use.

The station would be in continuous sunlight except for some weeks around the equinoxes, when it would enter the earth's shadow for a few minutes every day. Fig. 4 shows the state of affairs during the eclipse period. For



A project which goes part of the way towards the goal envisaged in this article has been put forward by Westinghouse in collaboration with the Glen L. Martin Co. of America. The radius of coverage would be increased from 50 to 211 miles by beamed radiation from an aircraft flying at a height of 30,000 ft. and equipped with television and FM transmitters.



**Extra-terrestrial Relays—**

this calculation, it is legitimate to consider the earth as fixed and the sun as moving round it. The station would graze the earth's shadow at A, on the last day in February. Every day, as it made its diurnal revolution, it would cut more deeply into the shadow, undergoing its period of maxi-

channels would be available.

(3) The power requirements are extremely small since the efficiency of "illumination" will be almost 100 per cent. Moreover, the cost of the power would be very low.

(4) However great the initial expense, it would only be a fraction of that required for the

ever, owing to its finite acceleration, the rocket loses velocity as a result of gravitational retardation. If its acceleration (assumed constant) is  $a$  metres/sec.<sup>2</sup>, then the necessary ratio  $R_0$  is increased to

$$R_0 = R \frac{a + g}{a}$$

For an automatically controlled rocket  $a$  would be about  $5g$  and so the necessary  $R$  would be 37 to 1. Such ratios cannot be realised with a single rocket but can be attained by "step-rockets"<sup>2</sup>, while very much higher ratios (up to 1,000 to 1) can be achieved by the principle of "cellular construction"<sup>3</sup>.

**Epilogue—Atomic Power**

The advent of atomic power has at one bound brought space travel half a century nearer. It seems unlikely that we will have to wait as much as twenty years before atomic-powered rockets are developed, and such rockets could reach even the remoter planets with a fantastically small fuel/mass ratio—only a few per cent. The equations developed in the appendix still hold, but  $v$  will be increased by a factor of about a thousand.

In view of these facts, it appears hardly worth while to expend much effort on the building of long-distance relay chains. Even the local networks which will soon be under construction may have a working life of only 20-30 years.

**References**

- "Radio-Relay Systems," C. W. Hansell. *Proc. I.R.E.*, Vol 33, March, 1945.
- "Rockets," Willy Ley. (Viking Press, N.Y.)
- "Das Problem der Befahrung des Weltraums," Hermann Noordung.
- "Frequency Modulation," A. Hund. (McGraw Hill.)
- "London Television Service," MacNamara and Birkinshaw. *J.I.E.E.*, Dec., 1938.
- "The Sun," C. G. Abbot. (Appleton-Century Co.)
- Journal of the British Interplanetary Society*, Jan., 1939.

**EUROPEAN FREQUENCY ALLOCATIONS**

THE Postmaster-General is understood to be planning an early Conference of interested parties to consider the allocation of frequency channels for the liberated countries of Europe. No detailed information on the scope of the Conference was available up to the time of going to press.

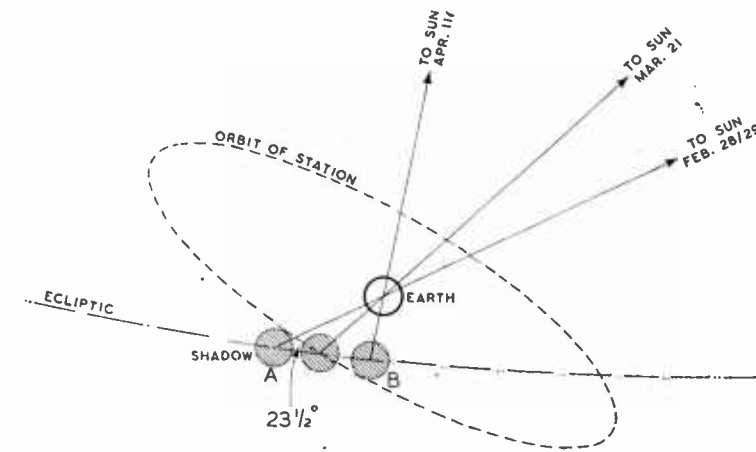

Fig. 4. Solar radiation would be cut off for a short period each day at the equinoxes.

mum eclipse on March 21st. on that day it would only be in darkness for 1 hour 9 minutes. From then onwards the period of eclipse would shorten, and after April 11th (B) the station would be in continuous sunlight again until the same thing happened six months later at the autumn equinox, between September 12th and October 14th. The total period of darkness would be about two days per year, and as the longest period of eclipse would be little more than an hour there should be no difficulty in storing enough power for an uninterrupted service.

**Conclusion**

Briefly summarised, the advantages of the space station are as follows:—

(1) It is the only way in which true world coverage can be achieved for all possible types of service.

(2) It permits unrestricted use of a band at least 100,000 Mc/s wide, and with the use of beams an almost unlimited number of

world networks replaced, and the running costs would be incomparably less.

**Appendix—Rocket Design**

The development of rockets sufficiently powerful to reach "orbital" and even "escape" velocity is now only a matter of years. The following figures may be of interest in this connection.

The rocket has to acquire a final velocity of 8 km/sec. Allowing 2 km/sec. for navigational corrections and air resistance loss (this is legitimate as all space-rockets will be launched from very high country) gives a total velocity needed of 10 km/sec. The fundamental equation of rocket motion is<sup>2</sup>

$$V = v \log_e R$$

where  $V$  is the final velocity of the rocket,  $v$  the exhaust velocity and  $R$  the ratio of initial mass to final mass (payload plus structure). So far  $v$  has been about 2-2.5 km/sec for liquid fuel rockets but new designs and fuels will permit of considerably higher figures. (Oxy-hydrogen fuel has a theoretical exhaust velocity of 5.2 km/sec and more powerful combinations are known.) If we assume  $v$  to be 3.3 km/sec,  $R$  will be 20 to 1. How-

# CONTRAST EXPANSION

## Design for a Negative Feedback Contrast Expander

By J. G. WHITE

(Concluded from page 278 of the previous issue)

TO avoid the high output impedance of the expander shown in Fig. 5 (a) of the previous instalment, voltage feedback is necessary, and is arranged over two stages in order that the input and feedback voltages may be in the correct phase relationship without using any coupling transformer.

In Fig. 6 (a) is shown a block schematic diagram of such an amplifier. If the gain of the amplifier without feedback is  $M$ , then it can be shown that the gain with negative feedback

$$M_1 = \frac{M}{1 + \beta M}$$

where  $\beta$  is the fraction of the output voltage fed back in phase with the input voltage.

To produce expansion of the applied signal, the resistor  $R_2$  is replaced by the anode-cathode AC resistance  $R_a$  of a valve,  $V$ . Negative bias, which increases as the amplitude of the signal, and is obtained from an auxiliary amplifier-rectifier system, is applied to the grid of the valve, so producing variations in  $R_a$ , and therefore in the feedback factor  $\beta$ ,

which equals  $\frac{R_1}{R_1 + R_a}$ . (See Fig. 6(b)).

By this use of a two-stage amplifier, the main criticisms which were advanced against the circuit of Fig. 5 have been disposed of. In addition, a larger part of the whole amplifier is subject to negative feedback, with a consequent extension of the benefits normally obtained thereby.

In the amplifier of Fig. 6 (b), let

- $M$  = gain of the amplifier without feedback
- $M_1$  = gain of the amplifier with minimum feedback
- $M_2$  = gain of the amplifier with maximum feedback
- $\beta_{min}$  = minimum fraction of the output voltage fed back
- $\beta_{max}$  = maximum fraction of the output voltage fed back

- $R_{a1}$  = maximum value of the AC resistance of  $V$
- $R_{a2}$  = minimum value of the AC resistance of  $V$
- $E$  = expansion of the audio volume range.

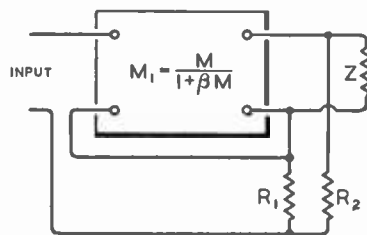

(a)

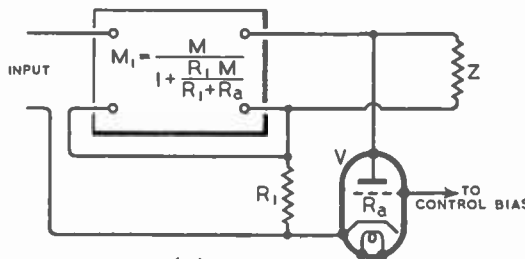

(b)

Fig. 6. (a) Block diagram of amplifier with feedback over two stages; (b) with the addition of a valve to control feedback.

$$\begin{aligned} \text{Then } E &= \frac{M_1}{M_2} \\ &= \frac{M}{1 + \beta_{min} M} \bigg/ \frac{M}{1 + \beta_{max} M} \\ &= \frac{1 + \beta_{max} M}{1 + \beta_{min} M} \dots \dots (1) \end{aligned}$$

If  $\beta_{min} M$  and  $\beta_{max} M$  are both large compared with unity,

$$\text{then } E = \frac{\beta_{max}}{\beta_{min}} \dots \dots (2)$$

$$\beta_{min} = \frac{R_1}{R_1 + R_{a1}} \text{ and}$$

$$\beta_{max} = \frac{R_1}{R_1 + R_{a2}}$$

$$\therefore E = \frac{R_1 + R_{a1}}{R_1 + R_{a2}} \dots \dots (3)$$

If  $R_1$  is much greater than  $R_{a2}$

$$\text{then } E = \frac{R_{a1}}{R_{a2}} \dots \dots (4)$$

In the later part of this article it will be seen, however, that the simplifying assumption leading to equation (2) is in most practical cases unjustifiable.

In Fig. 7 is shown the schematic diagram of a two-stage amplifier with voltage negative feedback from the output of  $V_2$  to the input of  $V_1$ , the resistance  $R_1$  in the cathode circuit of  $V_1$  forming with  $R_a$  a potential divider across the output of  $V_2$ . Current feedback occurs in the first stage, but is usually neglected in calculations of gain, as  $R_1$  may in most cases be assigned a sufficiently low value to justify this. In the present case, however, the expansion range may be appreciably reduced by this subsidiary effect, and it will therefore be taken into account.

A simplified block form of Fig. 7 is shown in Fig. 8. Let

- $m_1$  = gain of the first stage without feedback
- $m_2$  = gain of the second stage without feedback
- $\beta_1$  = fraction of the first stage output voltage fed back
- $\beta_2$  = fraction of the second stage output voltage fed back

Then the over-all amplification

$$\begin{aligned} M_1 &= \frac{\frac{m_1}{1 + \beta_1 m_1} m_2}{1 + \beta_2 \frac{m_1 m_2}{1 + \beta_1 m_1}} \\ &= \frac{m_1 m_2}{1 + \beta_1 m_1 + \beta_2 m_1 m_2} \dots \dots (5) \end{aligned}$$

The feedback voltages in the

**Contrast Expansion—**

circuit of Fig. 7 are developed across a common resistor,  $R_1$ . As a result, equation (5) is modified. In Fig. 7 let

- $\mu_1$  = amplification factor of  $V_1$
- $\mu_2$  = amplification factor of  $V_2$
- $R_1$  = cathode resistor of  $V_1$
- $R_2$  = AC resistance of  $V_1$
- $R_3$  = load resistor of  $V_1$
- $R_4$  = AC resistance of  $V_2$
- $R_5$  = load resistor of  $V_2$
- $R_6$  = feedback resistor from  $V_2$

Also let  $R'_5 = XR_5$ , where

$$X = \frac{R_1 + R_6}{R_1 + R_6 + R_5}$$

and  $\beta = \frac{R_1}{R_1 + R_6}$

The over-all amplification without feedback may be written

$$M_0 = \frac{\mu_1 \mu_2 R_3 R'_5}{(R_2 + R_3)(R_4 + R'_5)}$$

and with current and voltage negative feedback becomes

and a negative potential which increases with the amplitude of the signal is fed to the control grid. Thus the impedance increases with the signal and the feedback voltage is reduced, so increasing the gain of the amplifier.

In order to obtain a satisfactory degree of expansion the impedance of the controlling valve must vary over a wide range. It has already been stated that the range of volume as normally broadcast is not greater than 40 db, whereas the full range of a symphony orchestra is of the order of 70 db. It is suggested, however, that a maximum range of 60 db. is the most that will be needed or can be tolerated under listening conditions in the home. If the peak output of an amplifier is 15 watts on the loudest crescendo of a full orchestra, the softest passages will produce an electrical output of 15 microwatts. This represents

level tolerable to the human ear in a living room 15 ft. x 12 ft. x 10 ft. having a reverberation time of 0.4 second, would be produced by 90 watts electrical power fed to a speaker having 5 per cent. efficiency.)

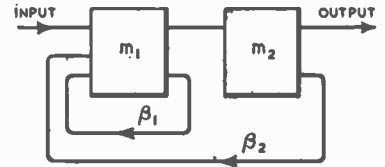

Fig. 8. Block diagram of amplifier of Fig. 7.

To produce an expansion of 20 db. it is necessary for the amplifier gain to vary in a ratio of 10 to 1. Examination of equations (5) and (7) shows that this entails a ratio of maximum to minimum voltage feedback ratios in excess of 10 to 1, the necessary increase being greater as the current feedback term increases. Thus current feedback should be kept as low as possible to ensure the maximum expansion for given values of  $\beta$  and  $M_0$  in equation (7). This may be done either by reducing the value of the cathode resistor  $R_1$  or by changing the other circuit constants of the first stage, at the same time maintaining the over-all gain without feedback at the same value. The first remedy unfortunately also affects the voltage feedback factor, and the second may prove difficult for several reasons, such as the types of valves available and the peak voltage required.

A variety of valves may be used in the control position, and ranges of impedance between 5,000 and 100,000 ohms are easily realised. The impedance of this valve, in series with  $R_1$ , shunts the anode load of  $V_2$  and at maximum feedback may reduce this load to a small fraction of its highest value. If  $V_2$  is a triode the load may then fall below the minimum necessary for low harmonic distortion. The effect may be reduced by connecting the high-potential end of  $R_6$ , i.e., the anode of the control valve, to a tap on  $R_5$ , or by using a pentode as  $V_2$ , such a valve normally working into a load much lower than its internal impedance. (Where the feedback voltage is

$$M_{I_1} = \frac{M_0 \left( 1 + \beta \frac{R_4}{\mu_2 R_3} \right)}{1 + \frac{(\mu_1 + 1)R_1}{R_2 + R_3} \left[ 1 - \beta \frac{XR_4 + R'_5}{R_4 + R'_5} \right] + \beta M_0 \left[ 1 + \frac{1}{\mu_1} \right]} \dots (6)$$

With values likely to be used in practice, equation (6) may be simplified so that

$$M_{I_1} = \frac{M_0}{1 + \frac{(\mu_1 + 1)R_1}{R_2 + R_3} (1 - \beta) + \beta M_0} \dots \dots \dots (7)$$

To obtain expansion of the signal,  $R_6$  in Fig. 7 is replaced by the anode resistance of a valve,

an acoustic output of 0.75 microwatt with the 5 per cent. efficiency of the average domestic speaker on a plane baffle. With the normal background noise in the average home a still smaller output would be lost, so that a volume range in excess of 60 db. would entail an increase in the output power on peaks. Such an increase would be impracticable as, assuming a minimum level of 15 microwatts, ranges of 63 db. and 70 db. would necessitate outputs of 30 and 150 watts respectively. (It is interesting to note that, according to Harvey Fletcher's computations, the maximum acoustic

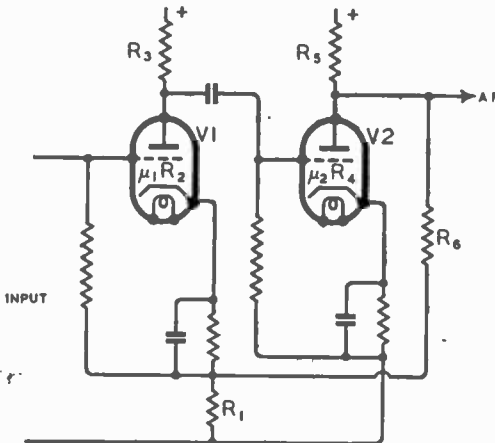

Fig. 7. Two-stage amplifier with voltage feedback over two stages and current feedback in the first stage.

taken from a tapping point on  $R_5$ , the feedback ratio  $\beta$  is reduced in the same proportion.)

After consideration of the foregoing discussion, it was decided to specify high-slope pentodes of the EF50 type in both amplifying positions, with a low anode load in the second stage. In addition, the voltage feedback was taken from a tapping on the output load to minimise the effects of a varying shunt load. The circuit, with component values, is shown in Fig. 9.

Where a valve such as an RF pentode has a load impedance much lower than its internal impedance, the stage gain may be written  $g_m R_1$ , where  $g_m$  is the mutual conductance and  $R_1$  is the load impedance. Similarly, the expression for gain in equation (7) may be written

$$M_1 = \frac{g_{m1} R_3 g_{m2} R'_5}{1 + g_{m1} R_1 + \beta g_{m1} R_3 g_{m2} R'_5} \quad (8)$$

where  $g_{m1}$  and  $g_{m2}$  are the mutual conductances of  $V_1$  and  $V_2$  respectively. The term  $(1 - \beta)$  in the denominator of equation (7) has been assumed to be equal to 1, as  $\beta$  is in most cases less than 0.1.

effect of  $V_3$ , varies between 3,675 and 3,270 times. (The limits of anode resistance of  $V_3$  have been taken as 100,000 and 5,000 ohms.) With feedback, the gain drops to 570 and 52 times respectively, so giving an expansion ratio of 11 to 1, or 20.8 db. approximately.

In Fig. 9 the signal output is taken from across the whole of the anode load. If it is taken from across the 2,000-ohm section of the load, the gains at minimum and maximum feedback become 228 and 17 times respectively and the expansion is approximately 22.6 db. Under these conditions the maximum output available from the stage is reduced by 60 per cent., and will not be sufficient to load an output stage directly unless high-slope output valves are used.

Although EF50 type valves have been suggested for  $V_1$  and  $V_2$  in Fig. 9, alternative types may be used. The theoretical results obtainable are easily calculable from the formulæ given. As a further example let us use a 6J7 for  $V_1$ , and a 6F6 for  $V_2$  and make  $R_1 = 1,000$  ohms,  $R_3 = 100,000$  ohms and  $R_5 = 6,000 + 2,000$  ohms. The gain with

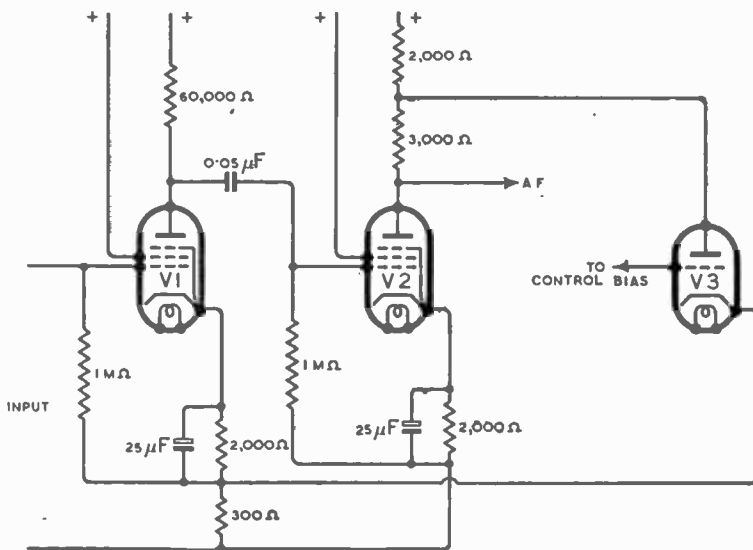

Fig. 9. Final circuit of suggested negative feedback contrast expander.

With the values shown in Fig. 9 and assuming the mutual conductances of  $V_1$  and  $V_2$  to be 3.5 mA/V under working conditions, the gain of the amplifier, without feedback but taking into account the shunt

minimum feedback is then 288 times, and with maximum feedback 29 times, giving an expansion of approximately 20 db.

The degree of feedback is high in the condition of minimum gain,

# GALPINS

ELECTRICAL STORES,  
408, HIGH ST., LEWISHAM,  
LONDON, S.E.13.

TERMS: CASH WITH ORDER. No C.O.D.

All Prices include Carriage or Postage.

**ELECTRIC LIGHT CHECK METERS**, first-class condition electrically guaranteed, for A.C. mains, 200/250 volts 50 cy. 1 phase 5 amp. load, each 12/6.

**POWER TRANSFORMER**, 4kW, double wound, 400 volts and 220 volts to 110 volts, 50 cycle, single phase. Price £20.

**AUTO TRANSFORMER**, step up or step down, 500 watt/5 tapped 0-110-200-220-240 volts. £3 10s.

**MOVING COIL AMPMETER** by famous maker, 2in. dia., flush mounting, reading 0-10 amps. F.S.D., 20 m/A, price 27/6.

**METAL RECTIFIERS**, large size, output 50 volts 1 amp., 35/-.

**SMALL MAINS TRANSFORMERS**, input 230 volts, output 11 volts 1 amp., 11/-.

**METAL RECTIFIERS**, large size, output 12 volts, 1 amp., 17/6.

**FIXED RESISTANCES**, size 12in. by 1in., fireproof, resistance 2 ohms to carry 10 amps., 3/- each; set of 16 mounted in steel frame, only 35/-.

**TRANSFORMER CORE** for rewinding only, complete with clamps, size approx. 2 1/2 k.w., price 25/-.

**50 VOLT MOTOR**, D.C., input 4 amps., 1/2 h.p., ball bearing, double ended shaft 1/2in. dia., slow speed, only 500 r.p.m., shunt wound, condition as new, also makes good slow speed generator. Price 50/-.

## FOR DISPOSAL.

10 K.V.A. High Tension Transformer Unit, 4 valve. Also combined diagnostic and superficial therapy apparatus, together with combined couch and screening stand. Tube stands and other accessories. Full particulars on application to above.

**MOVING COIL METERS**, all 2in. dia., flush mounting, 0-5 M/A, 40/-; 0-20 M/A, 40/-; 0-25 M/A, 40/-; 0-50 M/A, 37/6; 0-150 M/A, 36/-; 0-300 M/A, 35/-.

**MOVING COIL METERS**, all flush mounting, 2in. 0-5 amp., 30/-; 2 1/2in. 0-10 amp., 35/-; 0-1 amp., 2 1/2in., 30/-; 0-20 volt 2 1/2in., 35/-; Weston galvan. 50-0-50, 50/-.

**METAL RECTIFIERS**, outputs 6v-1 amp., 12/6; 6v-2 amp., 25/-; 9v-2 amp., 37/6; and 12v-4 amp., 50/-.

**ROTARY CONVERTERS**, 210v. DC to 180v. AC at 600 watts, £10; ditto, 230 DC to 150 AC at 700 watts, £10; ditto, 460v. DC to 300 AV at 4 k.w., £25.

**HT TRANSFORMER**, input 200/250v., output 3,000, 2,500-0-2,500-3,000 volts at 1,200 M/A, rating 7 k.w., £20.

**COOLIDGE TUBE**, filament transformers, 230v. input, 11 volts output, fitted HT insulator, insulation, 100,000v. to earth, 25.

**LARGE HEAVY DUTY CHOKES**, weight 24 lb., wound heavy gauge wire, suitable for rewinding; a auto transformer up to 1 k.w., price 25/-, carr. paid.

**LARGE PAXOLIN PANEL**, size 14 x 7 x 1/2in., fitted massive switch arm, 12 large studs and contact blade, very smooth action, price 7/6 each.

**BEAT FREQUENCY OSCILLATOR**, in case 21 x 11 x 9 1/2in., Lab. model, battery working, fitted 2in. dia. dual range voltmeter, reading 0-10-100 volts, complete with valves in working order, £10.

**ELECTROLYTIC CONDENSERS**, 2,000 MF, 25v. working, 10/- each.

**BLOCK CONDENSERS**, 2 MF, 1,500v. DC working, 7/6 each.

**BELL TRANSFORMERS**, output 3-5 and 8 volts, 6/- each.

**LARGE OUTDOOR BELLS**, 110v. DC working, 6in. dia. gong, 17/6 each.

**VOLTMETER**, 2in. dia., flush mounting, reading 0-250 volts, AC only, 35/-.

**MOTOR BLOWER**, fitted 12v. DC motor, aerocoona fan type, 2in. dia. inlet and outlet, very powerful, 45/-.

**X-RAY TRANSFORMER** in oil, input 200v., output 80,000 volts, rating 5 KVA, with Coolidge winding, £50; ditto, 2 1/2 K.V.A. at 90,000 volts, £45; ditto, dental type, 45,000 volts, £30.

**FLUORESCENT SCREENS**, self, 15 x 12, with lead glass, 25.

**CASSETTES**, set of four, new, £10; new head clamps, 35/-; leg cassettes, 70/-; Potter Bucky, £10.

CLOSED half-day Thursday. Open all day Saturday.

**Contrast Expansion—**

but with normal precautions in building the amplifier no difficulty should be experienced in obtaining complete stability. The phase shift in a two-stage amplifier, even at the extremes of the audio-frequency band, will only in exceptional circumstances be sufficient to give positive feedback. As stability is also dependent upon decoupling in the anode and screen circuits, adequate bypassing capacitors should be provided.

The frequency response of the amplifier will be adequate for present-day needs, any slight falling-off in the extreme bass and treble being counteracted by the high degree of feedback which occurs even at high values of gain. Similarly, the greater percentage of third-harmonic distortion produced by pentodes as compared with triodes will be reduced, and should not be greater than 0.4 per cent. at maximum gain and at an output at which  $V_2$  does not draw grid current.

It is not proposed to consider in detail the provision of variable bias for the control valve, as this may follow already well known principles. It is generally desirable, however, to avoid feeding the rectifier used to produce it directly from the signal channel. The introduction of an auxiliary amplifier contributes greatly to the avoidance of "flutter," enables a sufficiently high control voltage to be obtained, and facilitates the control of expansion. The time constants of the circuit may be chosen to suit the individual listener's tastes, and the methods employed may well follow the principles published in various papers during the last year or so. It may also be desirable to consider the introduction of a delay voltage into the control system, so that expansion occurs only above a certain signal level.

**Volume Compression**

Expansion is achieved in the amplifier described above by arranging  $V_3$  in Fig. 9 to have a low impedance in the quiescent state, and then biasing the control grid negatively to increase the internal impedance, so producing an increase in gain with signal amplitude.

If the control grid of  $V_3$  is

biased to cut-off in the quiescent state and a positive potential increasing with the signal is fed to the grid, negative feedback will increase with the signal. Thus the gain is reduced as the signal level increases, and compression of the volume range is achieved.

**BIBLIOGRAPHY****Negative Feedback Amplifiers**

"Some Properties of Negative Feedback Amplifiers," L. I. Farren, *Wireless Engineer*, Jan., 1938.

"Feedback," E. K. Sandeman, *Wireless Engineer*, Aug., 1940.

"Ultra-high Frequency Techniques," Brainerd.

**Contrast Expansion and Control Circuits**

"Low Distortion Volume Expansion using Negative Feedback," B. J. Stevens, *Wireless Engineer*, March, 1938.

"Contrast Expansion Unit," D. T. N. Williamson, *Wireless World*, Sept. and Dec., 1943.

"New Contrast Expansion Unit," M. O. Felix, *Wireless World*, March, 1944.

"New Contrast Expansion Unit," Letters to the Editor, W. C. Newman, *Wireless World*, May, 1944, and D. T. N. Williamson, *Wireless World*, June, 1944.

"Variable Contrast Expansion," W. E. Ingham and A. Foster, *Wireless World*, Aug., 1944.

"Contrast Expansion," Letters to the Editor, D. T. N. Williamson, *Wireless World*, May, 1943.

"A Simple Expander," W. Bacon, *Electronics*, Dec., 1941.

"Light-bulb Volume Expander," *Electronics*, March, 1936.

"Contrast Expansion Unit," MacFadyen, *Wireless World*, Dec. 18th, 1936.

"Radio Designer's Handbook," Chapter on Volume Expansion and Compression, F. Langford Smith.

**Miscellaneous**

"Auditory Perspective Basic Requirements," Harvey Fletcher, *Electrical Engineering*, Jan., 1934.

"Plate Resistance Control in Vacuum Tubes as Audio Gain Control Means," A. W. Barber, *Communications*, Oct., 1937.

"Acoustics of Small Rooms," J. Moir, *Wireless World*, Nov., 1944.

**PEACETIME RADAR****Applications to Civil Aviation**

LAST month, at the close of the third Commonwealth and Empire Conference on Radio for Civil Aviation (CERCA), a statement was issued on the use of radiolocation as an aid to air navigation. The statement is confined almost exclusively to what is described as "secondary radar"; that is, to navigational systems which do not involve echoes, but which depend on observation of signal transit time, either between an interrogatory transmitter on the ground and a triggered "responder" in the aircraft, or the reciprocal system—airborne transmitter and ground responder. Incidentally, there seems to be a tendency to prefer the former system, in conformity with the principle that major control should be from the ground. It is claimed that the use of radar will make it possible to determine the position of an aircraft much more accurately than by other methods. At the same time, the apparatus will act as a collision warning and enable the ground station to exercise more flexible control by identifying individual

aircraft, presumably by means of an adaptation of the wartime IFF device (Identification of Friend or Foe).

Sir Robert Watson Watt, who presided over the CERCA committee dealing with these matters, said that if we decide to divert a reasonable proportion of our technical design potential to adapting radar for the purpose, there was no reason why suitable apparatus should not be ready within a year or so.

An important decision was reached with regard to inter-airfield communication. Existing channels were thought to introduce delays quite out of keeping with the speeds of modern aircraft, and the view was expressed that means of direct communication for operational service messages should be provided between terminal airfields.

**OUR COVER**

THIS month's illustration shows a Naval radar aerial array for metre-band long-range warning equipment. IFF aeriels are above.



Letters to the Editor

“Fitting” Hearing Aids • Spreading  
Television Development • Rectifier  
Meters

“Cheaper Hearing Aids”

THE article by Mr. C. M. R. Balbi, in your August issue, raises a very interesting point. Can a machine be constructed which will enable a layman to make an accurate diagnosis?

Mr. Balbi apparently believes that it can. His “Predictor”—which appears to be no more than a specially built valve hearing aid with variable tone control and a calibrated ear-piece—is, he claims, a sufficient answer to the question.

I have long used such a device, under the name of “Audiometer” by which it is generally known, and have found it very useful in determining, to some extent, degrees of deafness and of upper register loss, but I would not trust readings made by some of my (otherwise quite intelligent) assistants. Nor are these the only points to be considered.

What of intermittent deafness—a very common form, arising from various causes: what of *Tinnitus* and other defects of hearing known to otologists: what of the person who can hear in a closed room but not in traffic? Such cases make up at least 50 per cent. of the hard of hearing.

Is Mr. Balbi unaware that the deaf are not only customers but patients: that *each one* must be individually treated and that service after sales make up at least half the Aurician’s business?

Incidentally, mass production of deaf aids is no new idea, and excellent models have already been on the market. None is now on sale—a fact that should speak for itself. A good wireless mechanic could certainly learn to repair deaf aids, but as for selling them over the counter, after a short conversation through the “Predictor” and a glance at some predictor curves—well, the salesman who did so would need to stay only a short while in each place, otherwise he might find his customers too regular in their

return visits to his liking or profit.

The “Predictor” may be—the Audiometer is—an excellent instrument in skilled hands, but if I were a radio dealer I should have great hesitation in installing one as the first step to entering on a cut-price hearing aid sales service.

J. CUNNINGHAM BEATTIE.  
Wigmore Street, London, W.1.

IN my opinion the person most suited to the task of selling hearing aids is the chemist—not the radio dealer, as suggested by C. M. R. Balbi in your August issue. Many chemists do optical work and fit surgical appliances as well as their ordinary work of dispensing prescriptions.

J. S. HILLMAN, M.P.S.  
Nuthall, Notts.

Adaptability of the Deaf

WE talk loosely about the need for the deaf to educate themselves in the use of hearing aids, but I have never heard a reasoned argument as to why it should be necessary. I wonder if your readers would consider the following to be a logical explanation?

A deaf subject, without artificial aid, adapts himself to some extent to his deficiency, and can follow speech and identify sounds, although what he actually hears would be quite unintelligible to a person with normal hearing. In effect, he has learned another language.

When such a deaf subject tries to use a hearing aid that restores normal response, he hears a confusion of sounds to which he is quite unaccustomed; again he has to learn a new language, or, rather, a forgotten language.

If I am right, it would seem that, at the first onset of deafness, the subject should make at least occasional use of a hearing aid. A deaf person who has failed to

**SOON  
CRONAME**

*Designing and  
Engineering*



will again be a factor in the plans of far-sighted manufacturers of electronic equipment. From building precision parts for wartime devices the Croname group will turn to the processing of mechanical and decorative items for the electronics industry.

A place in the *Croname* schedule has meant attractive, practical, saleable merchandise to many. Our facilities may be valuable to you.

Dial Scales.  
Tuning Mechanisms.  
Pointers. Escapements.  
Precision Controls. Knobs.

\*  
Exclusively Represented in  
Great Britain by

**FRANK HEAVER LTD.**  
Kingdsey Road, Bideford,  
N. Devon.

*Croname Incorporated*  
FORMERLY  
*Croname Plate & Manufacturing Co.*  
CHICAGO, ILL. U.S.A.



H.A.5 DEAF-AID  
CRYSTAL MICROPHONE

ASTATIC will be ready to serve you again with high quality piezo-electric devices when the ‘All-Clear’ of Victory sounds. Astatic deaf-aid microphones can be supplied only if Import Permits are established. Model H.A.5 illustrated is used as standard by America’s leading hearing-aid instrument makers.

**ASTATIC**

THE ASTATIC CORPORATION  
CONNEAUT, OHIO, U.S.A.  
and  
TORONTO, CANADA.

— Exclusively Represented by —  
Frank Heaver Ltd. Kingsley Road,  
Bideford, N. Devon

**Letters to the Editor—**

do so should use an instrument which would allow of a gradual improvement in response, starting from a point where the aid gave some overall amplification but very little wider frequency response than that to which he has been accustomed. The frequency response of the aid should then be widened gradually.

W. T. SMITH.

London, N.W.

**Radio Exports**

WHEN lecturing recently to a class of Indian students on the superheterodyne principle of reception, I tried to enliven the proceedings by discussing the features of a few well-known British superhets. To my surprise, none of the students had heard of any of the makes mentioned; the only trade names they knew were American or Continental.

"SEAAF."

**Television "Monopoly" ?**

THERE is one very dangerous recommendation in the Report of the Television Committee. This recommendation is that "The production of the new system should be open to competition among all firms—probably only a small number—capable of undertaking the production of a *complete system*" (italics mine).

So far as is known there is at present, owing to its patent holdings on the most effective electron camera devices, only one firm in this country capable of supplying an acceptable *complete* television system. An insistence upon the supplying of a complete system by any one firm is entirely unnecessary.

There are no valid reasons why a television transmitter contract could not be broken down into well-defined sections. For instance, electron cameras could be competed for independently of the main studio and transmitter equipments. Film transmission apparatus need not be supplied by the firm that supplies high-frequency feeders and transmitting aerials. The effective co-ordination of the work performed by the various contracting firms could safely be left to the B.B.C. engineers.

Such a logical splitting of any new television contracts would tend to distribute and encourage television research over wider fields, and would be a practical method of discouraging monopolistic tendencies.

W. A. BEATTY.

London, W.13.

**Telepathy or Radio Telepathy ?**

I MUST agree with Dr. G. D. Dawson and W. Grey Walter (your September issue) about the small induction fields of the 10-c/s brain currents, but I am not aware of any real evidence that there are not, in addition, radio-frequency currents. This, I feel, is the gap which remains to be closed: the evidence quoted on the effect of screening is inadequate unless some idea of the fields involved is given, for at the higher radio frequencies very small apertures suffice to let energy leak out. I should expect the effect of distance to be a reduction in the probability of an effect rather than in its magnitude; if the mechanism involved is a trigger mechanism, the effect, when produced, should be independent of stimulus.

H. A. Hartley's letter (the same issue) is typical of the unscientific approach which I feel has prevented any full investigation of the problem; mechanisms produced by the mind and astral phenomena are terms which demand definition. The only factual statement he makes is contradicted by Rhine. In the original experiments long training and practice were *not* needed, and most subjects had some natural gifts.

"RADIOPHARE."

**Rectifier Meters**

I IN your June issue W. H. Cazaly states that in order to convert a DC meter to read AC by the use of a rectifier, "some calculation is involved, and rectifiers vary so much in their characteristics that selection and individual testing are necessary for accurate results."

This is a misleading statement, and is based on a widespread misunderstanding of the way in which a correctly designed rectifier meter operates. It is necessary to realise that (with the ex-

ception of peak voltmeters, etc.) the instrument rectifier should never be used to rectify the unknown voltage to a DC voltage, which is then measured by the usual DC voltmeter. The reason for this is that the ratio of AC voltage to DC voltage given by a rectifier is inevitably a variable quantity, depending on temperature, load current and rectifier characteristics. However, the ratio of AC to DC current given by a full-wave rectifier can easily be made independent of the rectifier forward resistance, and this ratio is, in fact, 1.11 to 1 when the input current is sinusoidal.

Therefore, in order to convert a DC meter to read correctly on AC it is only necessary to think in terms of current, and then to convert the actual meter movement to an AC sensitive device by connecting an instrument rectifier directly to the moving coil, ignoring for the moment the shunts or series resistances. This "AC movement" will now need 1.11 times the current it originally required on DC for the same scale deflection, so that if the original voltmeter resistances are used in series with the AC terminals of the rectifier, the meter will read exactly 10 per cent. low on AC:

$$\left( \frac{I}{1.11} = 0.9 \right)$$

If new series resistances are to be wound for the AC voltage ranges, their values must therefore be made 0.9 times the corresponding value for the DC ranges. The voltage drop in the rectifier will be approximately 0.5 volt, so that the scale shape of all voltage ranges above, say, 50 volts, will be virtually unaffected by the conversion to AC.

For the AC current ranges shunts are not satisfactory, and a current transformer should be used, still remembering that the rectifier must be fed with 1.11 times the full scale DC current of the movement. For example, a 1mA moving-coil instrument would require 1.11mA AC for full-scale deflection. In such an AC ammeter the rectifier resistance cannot affect the accuracy, and, furthermore, the scale shape will be exactly the same as the original DC instrument. No calibration is necessary if the DC

instrument itself can be relied upon.

To sum up, the golden rules to be observed in converting a moving-coil instrument to read correctly on AC are as follow:—

- (a) Think in terms of current.
- (b) Connect the rectifier directly to the moving coil.
- (c) Use series resistances on the AC side of the rectifier for voltage ranges from 10 volts upwards.
- (d) Use a voltage transformer for voltage ranges below 10 volts.
- (e) Use a current transformer for current ranges other than that given by direct connection to the rectifier.

Thus, the calculation mentioned by your contributor becomes a simple multiplication by 1.11, and the question of individual selection and testing of rectifiers does not arise, as variations in the rectifier resistance cannot affect the meter reading.

A. H. B. WALKER.

Edgware, Middx.

[W. H. Cazaly writes: Mr. Walker's remarks are perfectly sound, and I am much obliged to him for making so clear certain points that might be misleading to readers. As far as voltage ranges—with which my article did not deal—are concerned, his methods are well known and easy to apply except when using rectifiers at low voltages, when deflections cease to be linear functions of the applied PD owing to the lower bend in rectifier characteristics. However, I think he will agree that "any old rectifier" cannot be relied upon to give desired results with the use solely of the simple and theoretically correct calculations he outlines. Surely it is necessary either to purchase rectifiers of known and suitable properties, or to find out something about the rectifiers that are available and have to be used and to select those that have the required characteristics. On current ranges Mr. Walker rightly advocates the use of instrument transformers in preference to resistance shunt networks, which, although quite practical, are a little complicated and may demand the use of more than one

scale on the meter. But it is not easy to design an instrument transformer on paper that will have the precise characteristics required, even when all the factors involved in the transference of energy from the primary to the secondary are known, and it is more difficult to construct such a transformer in the average workshop in a manner that will ensure its theoretical characteristics being realised in practice. An AC meter has to be regarded as a DC meter plus rectifier and transformer, and to test it for overall performance, as is required in calibration, a known test AC must be passed through the instrument as a whole. My device enables the magnitude of such a test current to be ascertained without the use of standard AC meters, which are rather expensive and seldom found in the average workshop.—ED.]

**"Those New Sets"**

BY now there must be tens of thousands of men in all branches of the Services who daily come in contact with radio apparatus containing between 30 and 60 valves. These men have become accustomed to using complicated gear so long as its controls are not "difficult"; and furthermore they have become accustomed to the superlative performance obtainable by using a few more "innards."

Whilst not advocating anything quite so advanced in either scope or price for broadcast reception, I would earnestly entreat all manufacturers to ponder awhile before inflicting their post-war programme of five-valve radiograms on 'all and sundry.

Price was never a deciding factor in the purchase of more ambitious radio equipment, but the majority of folk were a trifle scared at the hint of anything with valves running into double figures. This was the major problem I found in television receivers, but I feel the argument no longer holds water.

Now they are starting with a clean slate is it too much to hope for that at last we may get out of the rut of the basic super-hot FC-IF-D-AF-O?

G. KEATING.

Earley, Berks.

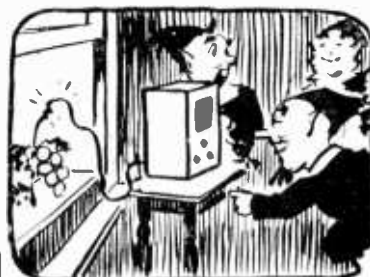

THE "FLUXITE GUINS" AT WORK

"I know this old set isn't worth the trouble—but why all the mirth?"  
Said the lads "Yes, all right It's fixed with FLUXITE."  
But tomatoes won't make a good earth."

See that FLUXITE is always by you—in the house—garage—workshop—wherever speedy soldering is needed. Used for over 30 years in Government works and by leading engineers and manufacturers. Of all Ironmongers—in tins, 8d., 1/4 & 2/8.

Ask to see the FLUXITE POCKET BLOW LAMP. Price 2/6.

TO CYCLISTS! Your wheels will NOT keep round and true unless the spokes are tied with fine wire at the crossings AND SOLDERED. This makes a much stronger wheel. It's simple—with FLUXITE—but IMPORTANT.

The FLUXITE GUN puts FLUXITE where you want it by a simple pressure. Price 1/6, or filled, 2/6.



ALL MECHANICS WILL HAVE  
**FLUXITE**  
IT SIMPLIFIES ALL SOLDERING

Write for Book on the .ART OF "SOFT" SOLDERING and for Leaflets on CASE-HARDENING STEEL and TEMPERING TOOLS with FLUXITE. Price 1s. each.

FLUXITE LTD.

(Dept. W.W.), Bermondsey Street, S.E.1

# UNBIASED

## A Great Opportunity

IT is with many misgivings that I read that the electrical industry is making plans to flood our homes with a torrent of domestic appliances of all types to make up for the six years during which the factories have been otherwise engaged. The reason for my misgivings is that in the absence of any legislation to check it there is bound to be a big increase in man-made static. No doubt the more reputable manufacturers will see to it that their products are properly "suppressed," but there are certain to be many firms of the other sort whose apparatus needs suppressing in more senses than one.

At the same time there is, to my mind, an even greater bugbear to pleasurable wireless listening than man-made interference, and that is the annoyance caused by the over-loud loudspeaker bellowing out its stuff next door. Usually the blame is laid on the owners of the offending loudspeakers, but to my mind the radio industry itself is largely, if indirectly, responsible for this particular curse and the curses it calls forth.

The trouble is not always due to thoughtlessness or to indifference to other people's feelings on the part of the set users. It is due to the simple fact, which music lovers must accept whether they like it or not, that most people use their wireless set, for fully 50 per cent. of their listening time, as a background for other activities in the house. This particularly applies to women, who are round and about the house more than their menfolk.



Noisy loudspeakers.

Since they are not always in the same room as the LS, but are, during part of the day at any rate, moving about here and there in the house, they turn the volume up to a very high level so that they can

By

## FREE GRID

hear it wherever they may be. If it so happens that they are actually "listening" to an item as distinct from using it as a background they will turn the wick up higher still.

The remedy for this state of affairs is simple: namely, to have two or three extension loudspeakers placed at strategic points in the house so that complete "coverage" is given at relatively low volume. It is no use the radio industry merely trying to sell an extra loudspeaker or two and leaving the wretched buyer to trail untidy extension wires through the house and to do his own matching of the LS to the output of the set.

I contend that it is up to the wireless dealer to sell not merely loudspeakers but to sell the idea of "she shall have music wherever she goes" to the average housewife, and having sold the idea, to carry it into effect by examining the premises, choosing the correct strategic positions for the loudspeakers and then putting the LS outlets on the skirting boards as neatly as an electrical contractor would put a power outlet.

Right now, when plans are afoot for all the new houses, is the time to get ahead with this idea and insist that LS outlets be installed at the same time as the ordinary power outlets. This would soon cure the noisy loudspeaker menace as well as increasing both the enjoyment of the listener and the bank balance of the wireless dealer and manufacturer to the mutual satisfaction of all concerned.

## Alice in Blunderland

THE passion of scientific folk for mottoes from the classics which they profess to scorn is about on a par with the fascination which royal and other titles have for many Americans, and "Diallist" does well to tilt at this little idiosyncrasy as well as at the amazing habit which the scientific motto fans have of departing wildly from that correctness and exactitude which is supposed to be the be-all and end-all of their existence.

Writing recently in the lay Press on the subject of radar, one of them gave a very graphic account of fly-

ing blind over Brussels and accurately pin-pointing the position of the Cathedral in that city, quite regardless of the fact that no bishop has his seat in the Belgian capital.

The whole trouble is, of course, that the average scientist thinks that an outside in churches means a Cathedral, and I have no doubt at all that in this particular instance the writer pin-pointed the massive bulk of the Church of St. Gudule and promptly did what he and his colleagues are always deprecating: namely, he jumped to an obvious but false conclusion. No doubt a bishop would put his foot in it equally as much if he started discussing radar. In fact, it seems to be a failing of all us mortals to be unable to preserve a discreet and tactful reticence when dealing with subjects a little outside our ken.



Blood-curdling details in 1910.

In all fairness to the scientists, however, I must point out that they are not, by a long way, the worst offenders in this Alice-in-Blunderland business. As I have often pointed out, the palm is held easily by the B.B.C. chiefly when dealing with matters of history as shown in their various scrapbooks. I may say that, writing before the event, I am expecting the B.B.C. to excel itself in the Dr. Crippen broadcast which will have taken place a few days before you read these remarks.

The Crippen case is of special interest to all readers of *Wireless World*, since wireless played so prominent a part in the arrest of the unfortunate and misguided little doctor. I will gladly provide the producer with a new and personally autographed bowler hat if he has managed to get all the details correct, more especially the wireless ones. It is much more important to do this than to set out to give blood-curdling and inaccurate details, as I well recollect the newspapers did in those far-off days before de Forrest put a grid into Fleming's diode.

I am thinking of awarding another bowler hat for the tallest radar story. So far, the winner is the author of the amazing episode of the detection by radar, from a submarine, of a shoal of jellyfish.

# WORLD OF WIRELESS

## FM FREQUENCY ALLOCATIONS

THE Federal Communications Commission has finally decided upon its recommendation for the frequency allocations in the 44-108 Mc/s band. It will be recalled that this band was not assigned until the results of FM tests to determine sporadic E interference were known.

The primary concern in the allocations in this portion of the spectrum was FM as this service is not assigned frequencies in any other band, whereas the other services for which provision is made have other allocations.

Of the three FM bands proposed, 50-68, 68-86 and 84-102 Mc/s, the second was dismissed as "completely unfeasible." The primary objection to the first was the amount of sky-wave interference. The F.C.C. report states that "interference among 50 kW FM stations at 58 Mc/s from sporadic E transmissions . . . might be expected for 140 to 480 hours per year at the 50 microvolt contour from stations 900 and 1,000 miles distant." It is pointed out that this interference would be concentrated in two or three summer months. In contrast at 84 Mc/s interference under these conditions "would be anticipated for only 6.5-25.5 hours per year."

The final allocations are:—

**FM**—educational 88-92 Mc/s, commercial 92-106 Mc/s.

**Facsimile**—106-108 Mc/s.\*

**Television**—44-50, 54-72 and 76-88 Mc/s.

**Non-Government**—42-44 and 72-76 Mc/s.

**Amateurs**—50-54 Mc/s.

\* This will eventually be occupied by FM when facsimile uses a higher frequency.

During the F.C.C. investigation considerable emphasis was placed on the hardship to the 400,000 owners of sets covering the old FM band of 42-50 Mc/s. It has, therefore, been decided to permit "interim operation" from 42-44 Mc/s.

## RADAR TRAGEDY

DURING Sir Stafford Cripps' address at the Radio Industry Council luncheon on August 31st, when he paid "tribute to the industry's outstanding contribution in the development of Radar—that great war invention," he referred to the "sad tragedy which accompanied the birth of H2S." He then recalled that it was whilst trying out the apparatus in the air that five of the small team working on it were killed in a flying accident in 1942.

Amongst those killed were "two of the most prominent engineers in the British television industry,

A. D. Blumlein and C. O. Browne, with their assistant F. Blythen."

Both Blumlein and Browne were on the staff of Electric and Musical Industries prior to being lent to the Government for research work on Radar.

C. O. Browne, who was a contributor to our sister journal, *Wireless Engineer*, was largely responsible for the E.M.I. television equipment installed at Alexandra Palace.

## AMATEUR LICENCES

IT is announced by the Radio Society of Great Britain that the G.P.O. has agreed to accept applications for radiating licences from amateurs who held Artificial Aerial Licences at the outbreak of the war. It is stressed, however, that some considerable time may elapse before licences are issued.

When making application to the Radio Branch W2/6 Engineer-in-Chief's Office (Alder House), G.P.O., London, E.C.1, applicants will be required to submit proof of their ability to send and receive the morse code. A Discharge Leave Certificate carrying testimony that the applicant served during the war in one of the recognised radio trades in one of the Services may be taken as proof of proficiency in morse.

Among the trades listed by the R.S.G.B. a few months ago as likely to carry exemption are: Naval telegraphists, Fleet Air Arm air gunners and observer officers, Royal Signals wireless and line operators and R.A.F. wireless operators.

## EXPERIMENTAL B.B.C. TRANSMISSIONS

IT is known that experimental transmissions on the television sound channel, 41.5 Mc/s, have been radiated by the B.B.C. for some weeks and it is understood that FM experiments are now being conducted on 46.3 Mc/s.

On enquiry from the B.B.C. it was officially stated that "normal experiments in broadcasting on ultra-short waves are being carried out by our own Research Department from Alexandra Palace but these experiments are not intended for public reception."

A further test transmission has now been called for by the Television Development Committee of the Radio Industry Council. It has made formal application to the Government for "the immediate introduction of a still pattern picture transmission from Alexandra Palace." This, it is stated, is

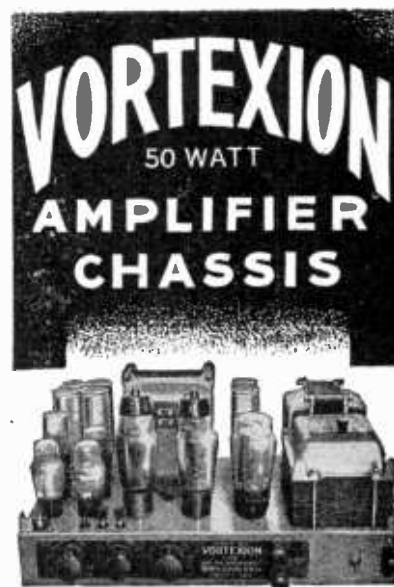

The new Vortexion 50 watt amplifier is the result of over seven years' development with valves of the 6L6 type. Every part of the circuit has been carefully developed, with the result that 50 watts is obtained after the output transformer at approximately 4% total distortion. Some idea of the efficiency of the output valves can be obtained from the fact that they draw only 60 ma. per pair no load, and 160 ma. full load anode current. Separate rectifiers are employed for anode and screen and a Westinghouse for bias.

The response curve is straight from 200 to 15,000 cycles in the standard model. The low frequency response has been purposely reduced to save damage to the speakers with which it may be used, due to excessive movement of the speech coil.

A tone control is fitted, and the large eight section output transformer is available to match, 15-60-125-250 ohms. These output lines can be matched using all sections of windings, and will deliver the full response to the loud speakers with extremely low overall harmonic distortion.

PRICE (with 807, etc., type valves) £18.10.0

Plus 25% War Increase

MANY THOUSANDS ALREADY IN USE

**VORTEXION LTD.**  
257, THE BROADWAY,  
WIMBLEDON, S. W. 19.  
Phone: LIBERTY 2814

**World of Wireless—**

needed for training rehabilitated Servicemen in the television industry.

**VOCATIONAL TRAINING**

**T**HE Government is now putting into operation the plans for the provision of free vocational training courses with maintenance allowances to assist in the resettlement of men and women who have been in the Forces or other work of national importance.

The Vocational Training Scheme aims at providing intensive instruction in order to help men and women whose careers have been interrupted to acquire a degree of skill which will enable them to reach craft status in the shortest possible time. Among the 20 or more occupations for which training schemes have been prepared is one for "radio servicing."

General information relating to the scheme is given in a leaflet (P.L.156) which is available to members of H.M. Forces through Service channels and through local offices of the Ministry of Labour.

**ANTIPODEAN ANNIVERSARY**

**T**WENTY-ONE years ago this month two-way radio-communication between this country and New Zealand was achieved by C. W. Goyder, who was then still at Mill Hill School, London.

Goyder, who is now Chief Engineer of All-India Radio, was operating with the call G2SZ and exchanged signals with Z4AA at Palmerston South on the morning of October 18th, 1924. The transmitters, operating on wavelengths around 100 metres, used powers of between 100 and 150 watts.

**PORTUGUESE RADIO CONTRACT**

**A** COMPLETE system of radio communications in the Portuguese East African colony of Mozambique is to be established at a cost of approximately £120,000 by Marconi Wireless Telegraph Company under the first important civil radio contract to be placed since the end of the European war.

Twelve short-wave telegraph-telephone stations will be erected under the supervision of British engineers at key points throughout the colony, which has an area of 260,000 square miles.

Three main stations equipped with high-speed telegraphy transmitting and recording apparatus are to be erected at Lourenco Marques, Beira and Nampula. The first two stations will also have telephone terminal equipment linked with the colony's internal telephone system.

**COMMERCIAL BROADCASTING**

**E**UROPE'S first post-war commercial broadcasting station is expected to start transmitting in October. Working on a wavelength of 416.5 metres, with a power of 60 kW, the station, Radio Andorra, is situated in the Republic of that name in the Pyrenees.

It will be operated by Empire Overseas Radio, a British company, and the programmes will be in French and Spanish. Coverage is not planned to include Great Britain at present.

**NEW FERRANTI RECEIVER**

**D**ESIGNED to cover short waves from 16.7 to 52 metres in addition to the usual medium- and long-wave ranges, this four-valve (plus rectifier) superheterodyne is the first domestic broadcast receiver to be produced by Ferranti since 1939. It is housed in a moulded bakelite cabinet and has a pentode output valve rated to deliver 4 watts. There



First post-war broadcast set.

is provision for an extension loud-speaker and gramophone pick-up sockets are also fitted. The price is £15 (purchase tax extra) and distribution will be through members of the Radio Wholesalers' Federation.

**POINT OF VIEW**

**I**T is difficult not to feel a bit sceptical about the extent of these changes [in B.B.C. organisation]. The new Light programme is obviously the old General Forces programme on a different wavelength, and in a centralised country such as this, so overwhelmingly much of the programme material necessarily comes from London that the independence of the regions cannot go very far. Moreover, all the programmes will suffer from the basic defects of a State-owned monopoly

—its shortage of funds, its sensitiveness to political pressure, its insensitiveness to listener preferences, its concentration on avoiding giving offence rather than on positively pleasing.

"These things will not be remedied until there is competition—in the same places, at the same times, in the same sorts of programme—between wholly separate organisations which stand to gain or lose by whether they please or bore."—*The Economist*, July 28th.

**PERSONALITIES**

**Thomas Kirkham** has resigned his position as Managing Director of Ericsson Telephones which he has held for fourteen years. He is succeeded by **Air Comdre. Hugh Leedham, C.B., O.B.E.**, who has been Director of Radio Research and Development, M.A.P. He was created a C.B. in 1942.

**W. F. Taylor**, who has been with the Telegraph Condenser Company for twenty years, has joined the Board of Directors. He will continue in his present capacity as Sales Manager of the Company's various sales divisions.

**Dr. R. C. G. Williams** has been appointed General Manager of the new Electronics Division of Murphy Radio; his deputy is **K. S. Davies**. The Division is responsible for research, manufacture and distribution of "electronic devices other than radio broadcasting."

**G. Bernard Baker** has been appointed head of all radio broadcasting research and development in Murphy's.

**A. A. Kift** has retired from Marconi's Wireless Telegraph Co. after 43 years' service. During the last twenty years he has successively held the positions of Sales Manager, Assistant Engineer-in-Chief and Contracts Manager.

**C. G. Carlton**, who for over four years before the war was Publicity Manager of McMichael Radio, has been appointed to a similar position with our Publishers, Associated Hiffe Press.

**IN BRIEF**

**I.R.E. Growth.**—The Annual Report of the Secretary of the U.S. Institute of Radio Engineers shows that the membership has increased by some 2,000, bringing the total to 13,137. Of the total membership 11.7 per cent. reside outside the United States. The increased membership in Great Britain was largely responsible for the addition of 111 members in Europe.

**Admission of non-members** to technical meetings of the Institution of Electrical Engineers, permitted under an arrangement introduced in 1943, is to continue. Those "who may consider that their technical experience and educational attainments do not suffice to admit them to any form of Institution membership" will, on completing the application form and payment of ten shillings, receive an invitation to the coming session's meetings.

**The greatest station construction**

boom in the history of broadcasting is foreseen in the U.S. when, on October 7th, the Federal Communications Commission starts issuing licences to the hundreds of applicants whose applications have been shelved during the war. According to *Broadcasting*, pending applications include 486 for commercial FM stations, 180 for commercial AM; 125 for commercial television and 25 for educational stations.

Opened on September 1st, the new direct radio-telephone circuit between Canada and Barbados, B.W.I., is operated by the Canadian Marconi Company and Cable and Wireless (West Indies). A radio-telephone service has also been opened between Barbados and Georgetown, British Guiana.

**Canada Calling.**—Regular transmissions to Europe in five languages, English, French, Dutch, Czech and German, are now radiated daily from 1100-2300 GMT from the Canadian international short-wave station at Sackville, N.K. Transmissions between 1100 and 2015 are radiated by CHTA on 15.22 Mc/s (19.71 metres) and from 2015-2300 by CHOL on 11.72 Mc/s (25.60 metres).

**RF Heating on Show.**—An exhibition of Radio Heating, conducted by Rediffusion, Ltd., for the benefit of industrial users of this equipment, is now being held at Dorland Hall, Lower Regent Street, London, S.W.1, and will remain open until September 28th.

**MEETINGS**

**Institute of Physics.**

*Electronics Group.*—"Recent work on the Theory of the Latent Image," by Prof. N. F. Mott, Bristol University, on October 23rd, at 5.30 in the Reid-Knox Hall, British Institute of Radiology, 32, Welbeck Street, London, W.1.

**British Kinematograph Society**

*Theatre Division.*—"Electronics and the Cinema"—II, by Geoffrey Parr, on October 21st at 11.0 in the G.B. Theatre, Film House, Wardour Street, London, W.1. Tickets obtainable from 2, Dean Street, W.1.

**INDUSTRIAL ENQUIRIES**

Exporters are invited to get into touch with a South African firm interested in direct import of broadcast receivers.

A firm in Finland wishes to hear from British wireless manufacturers not at present represented in that country.

An electrical firm in Madeira wishes to import British radio and electrical appliances.

British manufacturers of broadcast receivers and domestic electrical goods are invited to write to an importer in Cyprus.

A wireless firm in Brazil is interested in British broadcast receivers.

(Letters for the above enquirers, sent c/o The Editor, will be forwarded.)

A *Wireless World* correspondent, writing from Argentina, states that local factories are assembling broadcast receivers, and that there is a market for British components and accessories.

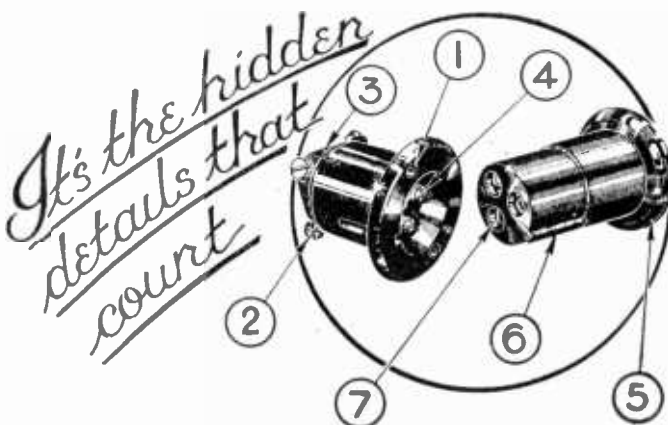

R.C.M.F. Standard Radio and light Electrical 3-pole or 2-pole + E. Connectors for removably joining mains leads to apparatus. Reg. Design No. 756088.

- 1.—Two-hole fixing (6BA @ 1 3/2" crs.) for apparatus-member, with flange outside.
- 2.—Terminals accept up to 1 x 16 s.w.g. (or equivalent flexible), firmly clamping connections.
- 3.—Adequate insulation between terminals and over surfaces providing excellent creep distances.
- 4.—Male contactor pins in apparatus-member (hence "plug") sunk below surface against accidental damage and intended to be wired 'dead' as normal for an 'inlet' member.
- 5.—Flex member or socket provided with large mushroom head for easy extraction and adequate internal space for gripping cord, with screw terminals accepting up to 23 x 36 s.w.g. per pole.
- 6.—Locating key which co-operates with slot, in plug member and polarizes the connections.
- 7.—Recessed sockets of live member (hence "socket") avoids accidental short circuit. Contact dimensions to R.C.M.F. standard for Radio Mains Connectors for 250 volts a.c. or d.c. 3 amp. max., or up to 6 amp. at lower voltages.

OVER 30 TYPES FROM WHICH TO CHOOSE.



The name "BULGIN" is a Registered Trade Mark.

A. F. BULGIN & CO. LTD., BYE PASS RD., BARKING, ESSEX.

Telephone : RlPpleway 3474 (5 lines)

# RECENT INVENTIONS

## PULSED SIGNALS

THE drawing shows an amplifier which is designed to favour the passage of non-sinusoidal signal pulses, transmitted at a definite repetition frequency, and to attenuate all other frequencies, thus ensuring a high signal-to-noise ratio.

A delay circuit D, of the open-ended transmission line type, is shunted across the output resistance R of the first valve V. The time constant of the shunt is such that it serves to reflect and build up voltages of the fundamental signal frequency, and its harmonics. It therefore presents a much higher impedance to them, when looked at from the anode of the valve V, than it does to any interfering fre-

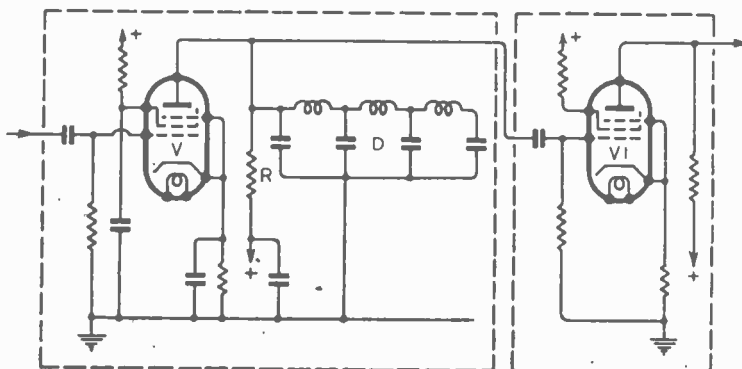

Pulse filter circuit.

quencies. The pulsed signals are thus passed on at full strength to the grid of the second amplifier V<sub>1</sub>, whilst all others are largely attenuated in the shunt circuit.

*Marconi's Wireless Telegraph Co., Ltd. (assignees of T. T. Eaton and D. G. C. Luck). Convention date (U.S.A.) September 11th, 1942. No. 568240.*

## HEARING AID

FOR frequencies below, say, 1,000 cycles a second, the directional or stereophonic effect in hearing is attributed to the time interval that elapses between the arrival of the same sound in one ear and the other, whilst for higher frequencies it is caused by a difference in intensity due to the acoustic shadow cast by the head. The two effects merge at different levels of frequency with different people, but both involve the independent use of each ear at substantially the same degree of sensitivity.

To meet these requirements in a hearing appliance for the deaf, a separate microphone-and-telephone set is provided for each ear, the two fittings being differently shaped so that the one for the right ear cannot be inadvertently applied to the left ear and vice-versa. The amplifying channel of each set in-

## A Selection of the More Interesting Radio Developments

cludes volume and frequency-response controls, which are pre-set by an expert for each particular patient. In addition, there is an overall volume control which affects both sound channels simultaneously and is operated, as desired, by the wearer.

*Murphy Radio, Ltd.; G. B. Baker; and J. H. Balean. Application date August 24th, 1943. No. 568027.*

lator is not sufficiently free from CW leakage for the purpose in view, it is replaced, according to the invention, by a "mechanical" arrangement based on the well-known principle of the radio-goniometer. If the carrier frequency  $f_1$  is fed to the fixed coils, and the search coil is rotated at the modulation frequency  $f_2$ , and the coupling between the two sets of coils is proportional to the cosine of the angle between them, then the output from the search-coil will contain the frequencies  $(f_1 + f_2)$  and  $(f_1 - f_2)$ , but neither of the frequencies  $f_1$  or  $f_2$  alone.

When the modulation frequency is too high for the search-coil to be rotated at the fundamental, the stationary coil is made in the form of a transmission-line loop, in which the carrier frequency builds up into a number of stationary waves, each influencing the search-coil in the course of a single rotation.

*Standard Telephones and Cables, Ltd., and C. W. Earp. Application date February 23rd, 1940. No. 567967.*

## VARIABLE CONDENSERS

A UNIFORM mixture of small conducting particles in a solid dielectric is used to make a type of variable condenser. As shown diagrammatically, the particles form a line of small condensers, arranged in series between the fixed lower plate P and an upper movable plate P<sub>1</sub>, more of the "series" lines being brought into parallel as the two plates increase their overlap.

Metal or carbon particles, about 40 microns in size, are mixed with a ceramic material, such as titanium oxide, which is then moulded under heat. To ensure adequate isolation of the particles, the volume of the dielectric should be twice that of the metal or carbon. The mouldings can be shaped to give any desired law of

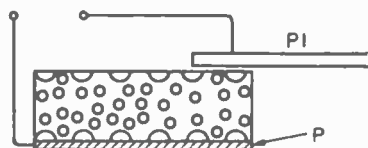

Composite dielectric condenser.

capacity change. For a rectangular slab the width should be about twenty times the thickness. One specified use of the composition is for making small trimming condensers.

*The Mullard Radio Valve Co., Ltd., and C. L. Richards. Application date June 25th, 1943. No. 567597.*

## SCREENING AMPLIFIERS

THE screening can and the deposited film of metal both tend to reflect heat back into the valve. With amplifiers of small dimensions, as used for very high frequencies, the resulting temperature may become excessive.

According to the invention, a protective layer of graphite, mixed with a suitable binder, is interposed between the glass bulb and the screening can or metal film. The graphite, when in close contact with both surfaces, is said to combine the property of good thermal conductivity with a high coefficient of absorption for radiant heat, so that it assists the outward flow of heat from the valve to the screen and absorbs the heat that would otherwise be reflected back into the valve.

*G. Liebmann and Cathodeon, Ltd. Application date October 29th, 1942. No. 567971.*

## RADIO BEACONS

IN a blind-landing system of the kind in which the path of descent is marked out by suitably modulating "offset" lobes of radiation, a clear-cut indication is secured by transmitting, from at least one of the directive aeri-als, signal sidebands that are free from any carrier wave.

As the ordinary balanced-valve modu-

The British abstracts published here are prepared with the permission of the Controller of H.M. Stationery Office, from specifications obtainable at the Patent Office, 25, Southampton Buildings, London, W.C.2, price 1/- each.



# The MULLARD *all-glass technique*

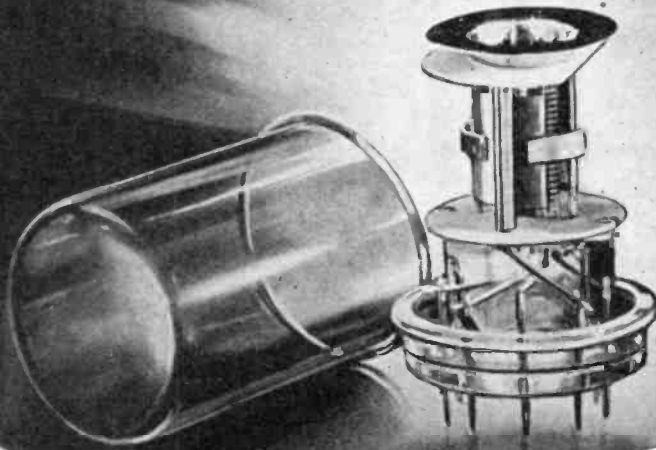

By a complete departure from the conventional form of valve construction, Mullard have effectively reduced the losses due to H.F. resistance, inductance and capacity effects within the valve itself and in the leads coming from the electrodes. The all-glass technique makes use of an almost flat circular glass pressing for the base of the valve, into which short pins are sealed, the electrodes being welded directly to the pins. By thus reducing the length of the lead-out connections, considerably improved efficiency at the higher radio frequencies has been achieved.

A  
DEVELOPMENT  
OF THE  
MULLARD  
LABORATORIES

Rate 6/- for 3 lines or less and 3/- for every additional line for part (inserted), average lines 5-6 words. Box Numbers 2 words, plus 1/- per Press Day; November, 1945, issue, first post Wednesday, October 10th. No responsibility accepted for errors.

### NEW RECEIVERS AND AMPLIFIERS P. RADIO SERVICES, Ltd., offer:-

NEW ac 4v receivers, £12/3/4; new 4v battery sets, £10/19; may we register your name for a new Pye, Ekco, Cosmor, etc., for supply when available; 5w ac/dc amplifier with valves, neat chassis construction, £6/10; Rothermel crystal pickups, 78/9; home battery chargers, output 12v 1 amp, £2/19/6; mains transformers, 350-0-350, 80ma 27/6; 120ma 35/-; Bryce stepdown transformers, 230/110v, 60w 30/-, 100w 35/-; 1st grade 3 core 0.3 amp line cord, 2/6 yd; volume controls, all values, 3/6, with switch 4/6; Rola 5in pm 18/6, 8in 19/6 (no trans.); Celestion 8in pm with trans 27/6, mains energised, 2,000 ohms field 36/-; Vitavox 12in pm, £26/18/6; universal output transformer, 6/6; 1,000w stepdown, 230/110v, £6/15; Bell transformers, 5/11; Meico moving coil microphones, 5sna; mike trans, 8/6; floor stand, 42/6; "B.L." 8mid 500v electrolytics, 3/1 (large stocks); vibrators, Mallory 6v 4-pin 12/-, Bulgin 6v 6-pin (self rectifying), 20/-; plug and distributor suppressors, 2/3; dynamo condensers, 2/6; telescopic aerials, side fitting, 21/-.

PURCHASE by post with confidence. Satisfaction guaranteed. All goods are brand new and latest type. Despatch same day. Postage or carriage extra under £4.

I.P. RADIO SERVICES, Ltd., 55, County Rd., Walton, Liverpool. Tel. Aintree 1445. (Estab. 1935.) [4138]

T.R.F. medium wave kit of parts, with drilled chassis and all components, condensers, etc., and circuit, nothing else to buy. £4; valves, £2/10; 5in speaker, trans., 27/6. HENRY'S, 5, Harrow Rd., Edgware Rd., W.2. COMMUNICATIONS, Ltd., "Dan".

C will have them as soon as trading conditions allow.—Remember—Dale Electronics, Ltd., 105, Bolsover St., W.1, Mus. 1023.

A NEW compact quality 6w amplifier for home use on ac mains, complete with built-in speaker and 5 valves, push-pull output; 10gns.—Chas. Britain Radio, Radio House, Wilson St., London, E.C.2. [4135]

AMPLIFIERS.—An amazing offer of brand-new Government surplus, 20w, 613a, in push pull, suitable for low impedance P.M. speakers, 50 only, definitely no more, at £8/15; carriage extra.—Cardings, 28, Dudley St., Wolverhampton. [4041]

QUALITY amplifiers, 200-250v ac, 5 watt 8½gns., 12 watt, £14; a.s.e. for fully illustrated leaflet and copy of "Design for Quality"; immediate deliveries.—J. H. Brierley (Gramophones and Recordings), Ltd., 403, Will St., Liverpool, 8, Lark Lane 1709. [3796]

HIGH quality receivers of exceptionally fine performance now being prototyped, deliveries expected to begin December. Limited supplies only; also multi-range ac/dc meter and new 1.5-300v ac/dc valve voltmeter; enquiries invited.—The Moreton Cheyne Company, B.M./R.F.M., London, W.C.1. [4038]

### RECEIVERS, AMPLIFIERS—SECOND-HAND

FOR sale, P.A. equipment:-

1 E.M.I. amplifier (230 volts, ac input) output; 2 6L6 push-pull with spare valves; complete in mahogany box with twin turntables and pick-ups and input for radio; 2 carbon mikes, one hand and one as stand; 2 ex-R.A.F. speakers, 4ft 6in long, 2ft 2in mouth, aluminium; 2 speakers, horn type, 4ft long, 1ft 10in mouth; 1 square wooden speaker; 1 flared wooden speaker, 3ft long, 3ft x 1ft 3in mouth; £65, or nearest.

1 TRIX amplifier (230 volt ac input), output 2 d.o. 26 in push-pull with spare valves, complete in oak box with twin turntables and pick-ups (individual fading control on each gramophone); Trix carbon mike on stand, 4 ex-R.A.F. aluminium horn speakers, 4ft 6in long, 2ft 2in mouth, 2 horn speakers, 4ft long, 1ft 10in mouth; 1 square wooden speaker; 1 flared wooden speaker, 3ft long, 1ft 3in x 3ft mouth; 24-volt rotary converter for mobile use, and 24-volt batteries for 12 hours' run; £100 or nearest.

ALL the above are in actual operation at present and can be seen and tested on application. All are complete for indoor or outdoor use, speech and music, and the last two completely mobile.—Enquiries, Spalding U.D. Council, Electricity Dept., 9, Winsor Rd., Spalding. 'Phone 2838. [4063]

R.C.A. AR.88.L.F. receiver, new condition; £50, or offer.—Box 3047. [4036]

BRIAN Savage 30-watt amplifier, only used twice; £28.—Tel. Loughton 3483; [4105]

MARCONI PHONE model 288, dc. 4-valve plus rectifier, in good working order; 13gns or offer.—Box 3419. [4151]

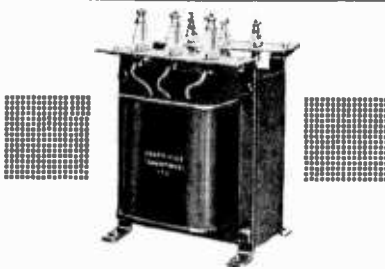

For the past 15 years we have devoted our energies exclusively to the manufacture of Transformers and Chokes. Although we continue to be very active in the field of Research and Development, we are nevertheless giving much of our attention to increasing our range of mounting facilities.

Illustrated above is one of the varied range of styles shown in our Catalogue which is now in preparation. If you would like a copy, please write to us (enclosing 1d. stamp) and we will send you one immediately it is ready.

Telephone



Abbey 2244

# PARTRIDGE TRANSFORMERS LTD

76-8, PETTY FRANCE LONDON, S.W.1

*This is a  
Pressing Subject*

*We now have power and  
hand press capacity  
available in all metals*

**MODERN PLANT —**

**MODERN METHODS —**

**HEAT TREATMENT**

*Complete assemblies too,  
if you prefer*

**HOWARD CLAYTON-WRIGHT LTD**  
TIDDINGTON RD., STRATFORD-ON-AVON  
PHONE: 3401-2-3. GRAMS: CLAYTONRITE, 3, ON A.

FOR sale, R.M.E.70 and DB20 Preselctor; £69.—Box 3053, c/o Wireless World.

HAMMARLUND Comet pro crystal model with speaker, £25 offer.—Box 3404.

WIRELESS short wave a.c. and d.c., 90-250 volts, set of spare valves, as new; offers.—Tel. Wembley 1696. [4065]

SAVAGE portable p.s. amplifier, ac, 12w output, complete with 7 valves, mic., 3 loudspeakers; £15.—Box 3151. [4063]

RADIO sets, amplifiers and radio sundries; list free; state needs.—A.C.S. Radio, 44, Widmore Rd., Bromley, Kent. [3806]

SELL, Hammarlund super Pro, 550 kc, 20 mc, 110-230v input, 12in. speaker, 16 watts output, spare valves; offer.—Box 3405.

NATIONAL H.R.O., complete 9 coils, but without power unit, unused, due to war service, except for test, offers; also Wireless Worlds." Aug. '43-July '45, inc.—Box 3054

TELEVISION receiver, complete sound and vision chassis, with 19 valves, 7,000-volt power pack, etc., but less 15in tube, £15; cabinet £5 extra.—Tanner, 22, Cole Park Rd., Twickenham, Peppergrove 5600. [4077]

SOUND SALES Fourband Super Six, new 1944, used few hours only, £29; Marconiphone car radio, 12v, £5; Magnavox Mod. 32 emer. speaker, 25/-; mains trans., 250v, 60ma, 27/6; 350, 120v 5/-.—Box 3148.

COMMUNICATION receiver, super R.M.E. C 69 with D.B. 20 unit, 14 valves, 6 watt band, covering 550kc to 32,000kc, 8 inch speaker, all in steel crinkle cabinets, cost £80; in first class condition, £70.

HALICRAFTER Sky Bubbly, 6 valves, 4 watt bands, 110 volt, with auto transformer, for 240ac, in good working order, £18. Also Rola M.E. 12 inch 15 ohms speaker, £5/15.

Wesey, 27, West St., Ashburton, Devon.

Hi-Fi amplifier with 12in speaker in infinite baffle enclosure, mike and p.u. inputs with mixer, bass and treble controls, 18watt output; £35; demonstration.—Robb, 4, Greenbank Ave., Little Sutton, Cheshire.

H.R.O. rack mounting with 7 coils and Hi power pack; also H.R.O. table model with 9 coils, power pack and 6-volt vibrator unit; what offers for either, or would consider exchange for car with cash adjustment.—Box 125, Parris, 121, Kingsway, W.C.2.

BAKERS'—New 7-valve "Wireless World" Quality amplifier with tone control stage, 8 watts push-pull triode output, price includes super Quality triple cone, 12in permanent magnet speaker, with large output transformer and all valves; also as above but with 15 watts tetrode output, ideal for realistic reproduction for public address; 2½d. stamp for particulars, prices, etc.—Bakers Selhurst Radio, Tel. Croydon 4225.

NEW MAINS EQUIPMENT

VORTEXION mains transformers, chokes, etc., are supplied to G.P.O., B.B.C., L.P.T.B.; why not you? Imitated but unequalled; orders can only be accepted against Government contracts.

VORTEXION, Ltd., 257, The Broadway, Wimbledon, London, S.W.19. Lih. 281.

NEW LOUDSPEAKERS

£5/18/6.—New Baker Super Quality 12in Auditorium permanent magnet speaker with triple cone, manufactured by Bakers Selhurst Radio, the pioneer manufacturers of moving coil speakers since 1925, wide frequency range, even response, ideal for quality reproduction, fitted with magnet, having exceptionally high flux density in the air gap, suitable for public address equipment when quality reproduction is first consideration; send 2½d. stamp for leaflet giving details of above and constructional details of a new acoustic chamber designed to extend loud speaker frequency range; also constructional details of an infinite baffle cabinet; every music lover interested in realistic reproduction should write for leaflet.

£8/19/6.—New Baker super power cinema permanent magnet speaker with 18in triple cone of new design, giving wide frequency response free from objectionable resonances; speech is clear and natural and music is reproduced with exceptional realism; fine engineering job, extremely sensitive, ideal for public address equipment when power handling capacity, plus realistic reproduction, is required; prompt deliveries by passenger train.—Bakers Selhurst Radio, 75, Sussex Rd., S. Croydon. Tel. Croydon 6813.

LOUDSPEAKERS, SECOND-HAND

VOIGT 1/coil twin speaker unit only; offers.—Box 3355. [4098]

B.T.H. RK Sen., 12in, 190v-250v, do field; best offer.—Box 3349. [4089]

GOODMAN'S infinite baffle speaker, perfect condition; £12.—39, Regent Rd., Stratton (Elmsbridge 2576). [4090]

LOUDSPEAKERS.—Quantity of reconditioned speakers, pm and energised, for sale.—Sinclair Speakers, 12, Pembroke St., London, N.1. [4088]

**VALVES**

All B.V.A. valves available, also number of discontinued types; list prices; pro form or c.o.t.—David Robinson, Ltd., 100, High St., Bedford. [3421]

**VALVES**, surplus to our requirements, tax free, sent C.O.D.: App4A, 10/6; 1P1220, 6/-; 1T14A, 11/6; APP4B, 10/6; M1111, 11/6; 1Y4, 11/6; 1B215S, 9/6; P12, 9/-; V02B, 10/6; 1D4, 5/6; 1P4118, 10/6; V148, 10/6; DD13, 5/6; P215, 6/-; B384, 11/6; 1H118, 10/6; 1P2B, 9/-; 577, 10/6; HR210, 4/9; SP48, 10/6; 6X56, 9/-; 1D210, 4/9; SP220, 6/-; 35, 10/6; DD74, 9/6; Larg's, Whitehall St., Dundee. [4155]

**DYNAMOS, MOTORS, ETC.**

SALE, res. tuned of signal generator: 440; 60ps-60k/s; lab. instrument.—Box 3353. New ac motors, 1/4hp, high starting torque. 200-250v. £5; 1/2hp, £5/10; 3/4hp, £7/10; 1hp, £9/15; all other sizes available; also machinery.—John W. Steel, Bingley, Yorks.

All types of rotary converters, electric motors, battery chargers, petrol-electric generator sets, etc., in stock new and second-hand; supplied against priority orders only.—WARD, 37, White Post Lane, Hackney Wick E.9. Tel. Amherst 1393. [1988]

**ELECTRADIX** dynamos and motors at bargain prices, dynamos, ht and lt G.E.C. double current, 6v and 600v, weight 17lb, 37/6, pkg. and carr. paid; supplied Eng. and Wales only; refund 5/- on returned cases; dc motors 1-5th hp and 1/4hp dc motors, enclosed, silent, 220 to 250v, 1,500 revs, double-end 1/2in shaft, first grade make, guaranteed, 1-5hp, £3/11 each; 1/4hp £4 each; all carr. paid Eng. and Wales; in stock.—Electradix, 214, Queenstown Rd., Battersea, London.

**GRAMOPHONE AND SOUND EQUIPMENT** COILS for filters, tone controls, all types of transformers for "Wireless World" circuits.—R. Clark, 30, Langland Cres., Stanmore, Wor. 5321. [4106]

**COMPLETE** disc recording equipment, with high-fidelity amplifier, mc mike, visual and head-set monitoring, play-back with two speakers, mixing channel, etc., perfect condition, suitable for lucrative whole or part-time business; will instruct purchaser if required; price £140.—Box 3354. [4095]

**RECORDING** gear.—Best offers next 14 days accepted. Pre-war prices given for guidance. V.G. 16in tracker and recording head, £28; Ekco 12in tracker, £5; heavy duty recording motor, 12in t/t table 100/250v ac/dc 331/78 rpm, £11; oak cab for latter, 24in x 16in x 6in, £3; playback motor, 12in t/t table 100/250v ac/dc 331/78 rpm auto-stop, £8; main spring motor, 4 1/2in wide springs, plays hr, winding, 12in t/t table, £8; accompaniment recording outfit, incl. 10in tracker, £3. Mostly new in makers' packing.—Bromley, 53, Harfield Rd., Sunbury-on-Thames, M/sex. Phone 2751.

**TEST EQUIPMENT**

**AVO 7, £22**; Taylor 45A valve tester, £20; both new.—Box 3344. [4076]

**ESTON** thermo-couple E ammeter, scaled 0-4 mv, coil 2ma, FSD, 25/-.—Box 3051.

**UNIVERSAL**, Avon brand, new, £49/10, or exchange camera.—Box 3050.

**CAMBRIDGE** Univipot millivoltmeter, 0.3 mv, full scale; £15 or nearest offer.—40, Whirlow Grove, Sheffield, 11. [4082]

**SUPREME 9v** "Diagnoscope" sig. gen. and oscilloscope (3in c/r tube), perfect, £65 or nearest; also other test equipment and components.—Harvey, "Dartinet", Kingsway, Gayton, Ches. [4150]

**SUPER** controller typ. 24, make Chauvin et Arnoux et Cie, Paris, for measuring electrical current and voltage, resistance transformation both for direct and indirect current, brand new; universal model 470 Cartex for measuring volts, ac and dc, resistance and capacity, brand new.—Box 3144.

**BOTH** new and unused, Avometer, model 7, 23gns; Avo test bridge, 13gns or best offers; Avo revolution counter, 4gns; brand new multi-plate full wave metal rectifiers, 24v 5 amp 42/6, 24v 2 1/2 amp 22/6, 12v 5 amp 25/-, 12v 2 amp 16/-; B.I. 500v 8 mfd electrolytics, 5/- ea.—Box 3388. [4117]

**CALLING** all hamst!—The experience gained in designing and building all types of test equipment in these six years of war will soon be available to you in first-class equipment of unusual accuracy at prices within reach of every ham; the first of those types will be ready within a matter of weeks; after that equipment will be designed and built to your needs; if you would like details of our new instruments immediately they are ready drop us a line now, and if you will tell us the type of instrument you need most urgently it will help us greatly in guiding our available labour and materials in those directions that are most urgent.—Banks (London), Ltd., 111, Clapham High St., London, S.W.4. Tel. Macculey 4488 0. [4046]

**PREMIER RADIO**

(MORE'S AND CO. (RADIO) LTD.)

ALL POST ORDERS TO:

JUBILEE WORKS, 167, Lower CLAPTON ROAD, LONDON, E.5. (Aldermist 4733.)

CALLERS TO:

169, FLEET STREET, E.C.4. (Central 2433.)

1945 LIST NOW AVAILABLE. HUNDREDS OF NEW LINES.

All enquiries must be accompanied by a 2d. stamp.

**10-WAY PUSH BUTTON SWITCHES COMPLETE WITH KNOBS AND ESCUTCHEON PLATE, SIX IRON CORED COILS, TRIMMERS AND PADDERS—NO CIRCUIT OR OTHER PARTICULARS AVAILABLE, TO CLEAR AT 12/6. ORIGINAL COST 45/-.**  
**METERS.** First grade army type Universal Test Meters in shockproof bakelite cases, ranges 10, 100, 500 volts at 1,000 ohms per volt A/C and D.C., 1, 10, 100, 500 m/a 13/c, 0-10,000 ohms, £3 15s.  
**FIRST GRADE METERS.** 3 1/2in. diameter, 1 milliamper, £2 12s.; 500 microamps, £2 18s. 6d. 4 1/2in. 1 milliamper, £3 5s.; 500 microamps, £3 11s. 6d. Westinghouse Meter Rectifier for either type, 10/-; Multiple shunts, 10, 100, 500 m/a, 10/-; Any value multiplier, 2/6 each. A/C/D AMPLIFIERS, 5 watts output, high gain, three-stage, feedback, £8 8s.

**BATTERY CHARGERS** for 2 v. batt. at 1 a., 25/-; for 2, 4 or 6 v. batt. at 1 a., 45/-; for 1 a., 30/-; for 2, 3 or 4 v. batt. at 1 a., 49/6; for 6 v. or 12 v. batt. at 4 a., 24/-.  
**MAINS TRANSFORMERS.** 300 + 300 m/a., 60 m/a., three 4 v. 2-3 a. windings, 25/-; 350 + 350 100 m/a. 5 v. 2 a., 6.3 v. 2-3 a., 29/-; 350 + 350 100 m/a., three v. 2-3 a. windings, 29/-; 300 + 350 150 m/a., 4v. 2-3 a., 4v. 3-4 a., 4v. 1-2 a. windings, 39/-; 350 + 350 150 m/a., 5 v. 2 a., 6.3 v. 2 a., 8.3 v. 2 a., 36/-; 500 + 500 250 m/a., 5 v. 3 a., 6.3 v. 2 a., 6.3 v. 4 a., 34/-; 425 + 425 200 m/a., 4 v. 2-3 a., 4 v. 2-3 a., 4 v. 3-4 a., 47/-; 350 + 350 150 m/a., 4 v. 1-2 v. 2-3 a., 34/-; 3-4 a., 38/-; 500 + 500 150 m/a., four 4 v. 2-3 a. LT windings, 47/-.

**1-VALVE BATTERY S.W. RECEIVER.** with 2-volt valve, 4 coils, 12-170 m. bandsread tuning, 55/-, including tax.  
**STEEL CHASSIS.** 10 x 8in., 2 1/2in., 7/-; 16 x 8in., 3/6; 20 x 8in., 0/6; 12 x 9 x 2 1/2in., 7/9.

**SHORT-WAVE COILS** fit octal sockets, 4-pin aerial coils, 9-15, 12-26, 22-47, 41-94, or 76-170 m., 2/6 each; 150-350 or 255-450 m., 3/-; 490-1,000 or 1,000-2,000 m., 4/-; 6-pin I.F. Trans., 9-15, 12-26, 22-47, 41-94, or 76-170 m., 2/6. S.W. chokes, 10-100 m., 1/3; 5-200 m., 2/6.

**SHORT-WAVE CONDENSERS**, easily ganged, 15 mfd., 2/11, 25 mfd., 3/3, 40 mfd., 3/3, 100 mfd., 3/11, 160 mfd., 4/8, 250 mfd., 5/8; shaft controls, 6d.; flexible diode, 1/-; Dual bandsread coils, every type available, 6/6.

**AIR DIELECTRIC CERAMIC TRIMMERS.** 35, 50, or 100 pf., 1/6 each.  
**MIDGET "P" TYPE COILS.** 12-35, 16-47, 34-100, 91-261, 250-750, 700-2,000, 200-557, available as I.F. trans., aerial, or osc. coils, 2/3 each. Valves, locators, 2/6 each; wafers, 1/6 each. Small 2-gang condensers: 0.0005, 12/-; Matched pairs iron-cored 465 K.C. I.F. trans., 15/- pair; midget type, 21/- pair, 60 mfd., trimmers, 1/-; osc. paddler, 750 mfd., 1/9; B.P.C. coil, 2/-.

**CONDENSERS.** All small tubular type, 25 mf., 35 v.v., 50 mf., 12 v.v., 10 mf., 50 v.v., 1 mf., 500 v.v., or 20 mf., 15 v.v., 2/3 each, 2 mf., 350 v.v., 2/9, 4 mf., 450 v.v., 3/8 8 mf., 450 v.v., 4/9, 16 mf., 450 v.v., 7/6, 20 mf., 450 v.v., 8/6, 16 + 8 450 v.v., 8/6, 16 mf., 180 v.v., 4/9, 50 mf., 50 v.v., 3/-, 8 + 4 mf., 450 v., 7/6, 32 mf., 450 v., 8/6.

**CRYSTAL PICKUPS.** Cosmocond, £2 11s. Rothermel super, £3 18s. 9d.  
**AMERICAN VALVES.** 4525, 3525, 2525, 12AK7, 12AK7, 2525, 6V6, 6X4, 6Z4, 80, 617, 6K7, 1N5, 1C5, 1H5, 1T5. Many others available.

**SUPER GIANT PUSH-PULL INTER-VALVE TRANSFORMERS.** 21/-, Midget type, 12/6.  
**MOVING COIL SPEAKERS.** Rola 5in., 2/6; 6 1/2in., 22/6; 8in., 24/-; Goodman 3 1/2in., 30/-; Above are low impedance trans. Price 8in. P.M. with trans., 29/6. 8in. 1,200 ohm energised speakers, 35/-; Midget standard or P.P. trans. for any above, 10/6. Super quality giant Matchmaker output transformers, match any tube single or P.P. 50 any voice coil, 10-watt, 30/-; 30-watt, 40/6; 60-watt, 59/6.

**CHOKES** 8H, 300 ohms, 40 ma., 4/6; 30H, 400 ohms, 60 m/a., 9/6; 30H, 100 m/a., 400 ohms, 15/-; 30H, 185 ohms, 150 m/a., 25/-; 25H, 280 m/a., 120 ohms, 39/6.  
**SHIELDS.** 2 mm. 8in. diameter, 21d. yd.; reinforced solder, 6d. per coil or 4/6 per lb.; screened 2-pin plugs and socket, 6d.; ditto, 8-pin, 2/-; Octal sockets, 6d.; ditto, suphetal type, 1/-; Valve screens 1/2. 6-volt vibrators, 4-pin, 12/6. 50ft. Indoor Aerial, 2/6.

**MULLARD** Master test board, type 7629, latest model, in perfect condition, complete with cards; £35 or offer.—Owen, 538A, Mansfield Rd., Nottm.

**OSCILLOSCOPES**, signal generators, multi-range test meters, etc., best gear of every description, British or American, repaired, serviced, recalibrated.—A. Huckelbae, "Haziejohn", Crofton Lane, Orpington, Kent. [3031]

**CONSTRUCT** your own crystal controlled frequency standard, using the new Q.C.C. type Q5 100 kc/s quartz crystal unit; in a single valve Colpitts oscillator circuit it provides check points of 0.01% accuracy at 100 kc/s intervals from 100 kc/s to 15,000 kc/s, making an ideal radio frequency source for receiver calibration and alignment; price 45/-, complete in octal based mount; send stamp for leaflet Q5, which gives full technical details and circuit.—The Quartz Crystal Co., Ltd., 63-71, Kingston Rd., New Malden, Surrey, Tel. Mal. 0334. [4102]

**COMPONENTS—SECOND-HAND, SURPLUS VALUE!** Matt has it!

**LINE CORD.**—2-way 2/6 per yd., 3-way 3/- per yd. (approx. 60 ohms per foot).

**SPEAKERS.**—"Celestion" P.M. 2 1/2in., less trans., 27/-; 8in. P.M., with trans., 27/6; 6 1/2in. P.M. (multi-radio trans.), 28/6.

**TWO-GANG**; condensers—0.0005, 12/6; Midget coils, h.f. and aerial, 4/6 per pair.

**VALVE** holders (all types). Volume controls, less switch, 2/9; with switch, 3/9.

**MAINS** transformers, 4v and 6v, 27/6.

**ROPIERME** (crystal) pick-ups, metal, 8s, £3/13/6; Senior de Luxe, £3/18/9.

**LET** us quote you for all your requirements. Cash with order, plus postage.

**MATT RADIO SERVICE**, 152, Richmond Rd., Kingston-on-Thames, Surrey. [4159]

**SOUTHERN RADIO'S** wireless bargains.

**LATEST** radio publications.—"Radio Valve Manual," equivalent and alternative American and British types, with all data, 3/6; "Radio Circuits," fully illustrated receivers, power packs, etc., 2/-; "Amplifiers," fully descriptive illustrated manual of circuits, 2/-; "Radio Coil and Transformer Manual," 2/-; "Short Wave Handbook," 2/-; "Manual of Direct Disc Home Recording," 2/-; "Test Gear Construction Manual," 1/6; "Radio Pocket Book," formulas, tables, colour code, etc., 1/-; "International Short-wave Station List," 10/-; "How for Radio Constructor," 1/-.

**SWITCHES.** 3-way 4/1, 8-way 6/- (all complete with knobs); escutcheons for 8-way press button switches, 1/6; knobs, pointer type, black or brown instrument types, 1/2-inch holes, 1/- each; all types of set knobs, black and brown, 1/2-inch holes, 1/- each; resistances, brand new, wire ended, 1/4, 1/2, 1 and 2 watt, assorted value, mainly low 22/-, per 100; heavy duty chokes, 1/-, 30 henries, 250 ohms, 120ma, 14/-; 500 ohms 15/-, 1,000 ohms 17/6.

**VALVE** type rotary switches, 11-way, single bank, 6/6; one lb assorted screws, 5/-; assorted soldering tags, including spade ends, 6/- gross; Multicon mica condensers, 28 capacitors in one from 0.0001 upwards, 4/-; International octal base valve holders, moulded and paxoline types, 1/- each, 10/6 per dozen; postage stamp trimmers, 30 pf, ceramic and paxoline, 1/- each.

**SOUTHERN RADIO SUPPLY CO.**, 46, Lisle St., London, W.C. Gerrard 6653. [3630]

**RADIO REPAIR SERVICE**, 36, Stonefields Lane, Edgware, Mdx. Mill Hill 1901.

**HIGH-GRADE** components at the lowest prices.—We offer the following new goods:—P.M. speakers, less transformer, 2 1/2in 22/-, 3 1/2in 25/6, 5in 20/-, 6 1/2in and 8in, 19/9; also with transformer, 10in 32/6, 8in 22/-; 0.3amp 3-way line cord, 60-70ohms per foot, 0.3amp 3-way lengths, 15/- length; auto transformers, 240-110, 75watts, 18/- each; output transformers, midget, 5/3; power pentode, 5/3; standard pentode, 5/-; special heavy duty pentode, 6/6; multi ratio type, 7/3; inter valve transformers, 3-1 and driver class B, 7/- each.

**GOODS** sent only c.o.d., carriage paid for orders £5 and over; under £5, 6d. for postage.

**PRICE** list 1d., unequalled range, example value.—Vaxley 4-bank 6-way switches, 5/6.

—Taylor, Macaulay St., Huddersfield. [3595]

**FOR** sale, limited quantity "Pyrex" 10in spreaders, 10/- per dozen plus 2/- packing and carriage.—T. H. Colebourn, 61, Victoria St., Douglas, I.O.M. [4096]

**MAINS** transformers, brand new, 350/0/350v, 4v 4a and 4v 2.5a, or 6.3v 3a and 5v 2a, 20/- ea.—Anloy Radio, 36, Hindeen Lane, London, S.E.2. [4122]

**H**ADPHONE units, a first-class product by leading American manufacturer, useful as efficient mike; limited quantity at 3/6 each or 6/6 per pair; postage paid.—Potter, Bishop Rd., Great Carleton, Blackpool.

**ELECTROLYTIC CONDENSERS**

now available, but supplies limited.  
Our New List, 2fd. post paid, contains details.  
Examples : 8 mfd. 450 v., 4/-; 8-8 mfd., 5/4;  
16-8 mfd., 6/3; 25-25 mfd., 1/9.

**ROTHELM** Crystal Microphones, D.104 from stock, 95/-; Popular brand Moving Coil Microphones, 65.

**WAVEBAND COILS** are proving an enormous success; don't miss special price offers: Midget medium wave coils, 3/9 pair. Medium and Long wave, 7/6 pair. Medium, Long and Short wave, 11/6; all with wiring diagrams.

**WAVEBAND I.F. Coils**, 465 K.C., neat construction, 13/6 pair.  
**TRANSFORMERS** for 6L6 Valves, 29/6. Matching Driver trans., 14/6.

**CHOKES**. Heavy duty chokes, 30 hen, 200 ohm, 120 ma., 17/6; \*500-0-500 v. Transformers available in 6 v. or 4 v., reduced to 30/-.

**SPEAKER FIELDS**, 1" centre, any resistance, 8/6 each.

**STEEL CABINETS** with chassis 19" x 10 1/2 x 9 1/2, 63/-; 12" x 7" x 7", 39/-; undrilled chassis 18" x 9 1/2 x 3 1/2, 10/6; 8" x 6 1/2 x 2", 5/6; transmitter racks with 4 panels complete with frame, fender, chassis mounts, etc., price on application.

**CELESTION 8" P.M. Speakers**, ONLY 25/6 each; 2-gang .0005 Condensers with slow motion, 15/6; 2-gang short wave .000075, 15/6 each.

**VOLUME CONTROLS** with switch, every value, 5/9; carbon resistors, 1 watt, 8d, each, or 7/6 doz.

**SWITCHES**. "On-Off" Toggle switches, 2/9; DP Change-over or DP "On-Off", 5/6 each; SERVISOL, 5/- per tin.

**"RADIO INSIDE OUT."** The repair man's finest reference book, 4/9 copy. Set of 6 American Service Manuals, 75/-.

**NOTE**.—With the exception of Books, sufficient must be included to cover postage or carriage costs.

EXCLUSIVELY MAIL ORDER

**WAVEBAND RADIO LTD.**

63 Jermyn St., St. James's, London, S.W.1.  
Phone: REGent 3055/6.

**PITMAN**

**BOOKS**

SECOND EDITION

**CLASSIFIED RADIO RECEIVER DIAGRAMS**

By E. M. Squire. This work gives a diagrammatic survey of modern radio receivers, and provides the practical radio man, service engineer, dealer and amateur with a ready reference to a representative selection of the types of circuit likely to be met with in the majority of receivers. Second edition. 10s. 6d. net.

**RADIO SIMPLIFIED**

By John Clarricoats. Specially prepared for all those making their first study of radio, and requiring a good basic knowledge of the subject, in the shortest possible time. The explanations are simple and lucid, and there are numerous diagrams to illustrate the text. Second edition. 4s. 6d. net.

N.B.—Paper rationing means a shortage of books. The one you want may be temporarily out of stock.

PITMAN HOUSE, PARKER ST., KINGSWAY, W.C.2

**MAINS transformers**, brand new, boxed, wire ends, universal fitting, 6v or 4v, 14/-, carriage extra; one doz. minimum quantity.—Cardings, 28, Dudley St., Wolverhampton.

**COMPONENTS**.—4mfd electrolytics 500v 5/-; 16mfd 350v 4/-; post 6d. Valves, British and American types; Celestion speakers, with and without cabinets; Gardiners range of transformers; Imhof needles, sharpeners, etc.; send requirements.—Weather, 6ad's, Blethley, Bucks.

**PARTS**.—Large P.F. transformers, 1v 240 input, 25-1 output; Ferranti AF3 AF4, Jensen 12in quality pa speaker; Baker infinite baffle speaker, 1in ply, Rothelmed pick up; offers; want 6, Voigt corner horn and lightweight cone, less unit.—Box 3358.

**SERVICESMEN**.—The following products are well designed and of high quality; volume controls, carbon type, all values, with or less switch, wire-wound resistors, 1 to 60watts; dropper resistors .02 and 0.3amp; line cords and razor resistors; terms and quotations on req.—Dagole, Ltd., 5, Torrns St., London, E.C.1.

**BRAND** new, pre-war, from storage, 4 battery radio chassis, var-nu 11F pen detector, pentode MW and LW, wired working, no valves, scales or speaker, 50/- each; 12 Bola 8in energised 2,000ohms, less O.P.P., 9 mains transformers, primary tapped 200/250, secondaries 350-0-350 100 ma 4v 4 amps, 4v 3 amps, 4v 2 amps; all at 22/6 each.—Box 3048.

**PHILIPS 3** wave a and hf coils, 7/6 pr., last hundred or so; ex R.G.I.D. mains trans 4v x 4v x 350v x 180ma, 35/-; 8mfd tubular electrolytics, 7/6 each; 8mfd cardboard, 8/3 each; CR tubes, ECR30 63/-, ECR35 126/-. ECR60 147/-; high class O.P.T. universal interleaved 9/-, B.V.A. valves and 3Q5s P.A. equipment; stamp for list.—Gregory, Union St., Cheddar.

**MOVING coil** hand microphones, p.m., energised by Alni magnets, 45 ohms, 1/2in coil, fitted with switch in handle; 12/6 each.

**MOVING coil** headphones, p.m., energised by Alni magnets, 45 ohms, 1/2in coil, ideal for mikes, miniature loudspeakers, etc, 1 1/2in overall in bakelite cases with 3in front flange, 7/6 each, per pair with headband 16/6; throat microphones, fitted with elastic bands, phone, plug, etc, 7/6 each.

**SYNCHRONOUS** motors, Sangamo, 200-250 volts ac, 50c, self-starting, fitted reduction gears, ideal movements for time switches, industrial, dark room, electric clocks, etc, rotor speed 200 rpm, final speeds available: 1 rev 12 mins 22/6, 1 rev 30 mins 25/-, 1 rev 60 mins 25/-; consumption 2 1/2 watts, size 2 1/2 x 2 1/2 x 1 1/2in; cash with order; registered post and packing 1/- extra.  
TERMS: Cash with order.—H. Franks, Scientific Stores, 58, New Oxford St., W.C.1. Tel. Museum 9594. [3961]

**BUY** direct and save pounds.—Stock list examples: Our proved Super Victory IV ac-dc complete kit, now £619/6; i.f.s. 1in x 1 1/2in 460kc/s, 7/6; midget 2-gang with slow motion, trimmers, 13/6; 8-1 drive, pointer, dial, acetone, glass, round or square, 7/-; full vision, 8/6; ex-bomb disposal telephones, receive, send, precision job, new, £4/19/6 ea.; best quality line cord, 60ohms per ft, 2-way 1/6, 3-way 2/- yd; send id. for lists. **BUCLEUCH RADIO MANUFACTURERS**, Melville Terrace, Edinburgh. Tel. 42803 Grams, Thermo, Edinburgh. [4143]

**COTTON-COVERED** copper instrument wire 1/2lb reels, 18, 20, 22, 24 gauges, 1/6; 26, 28 gauges, 1/9; 30, 32g, 2/-; 34g 2/3; silk covered ditto, 2oz reels, 24, 26, 28g, 1/6; 30, 32, 34, 36g, 1/9; 42g, 2/-; 18g double silk, 1lb, 5/-; B.A. thread screws, 1 gross useful sizes, 2/6; ditto, nuts, 2/6 gross; assorted gross screws and nuts, 2/6; ditto, brass washers, 1/6 gross; fibre washers, 1/6 gr; assorted solder tags, 2/- gr; assorted small eyelets and rivets, 1/6 gr; rubber-covered stranded copper wire, 1d yard; heavier quality, 1 1/2d, yd; very heavy quality, 2 1/2d, yd; ideal for aerials, earths, etc.; tinned copper connecting wire, 20ft coll, 6d; ditto, rubber covered, 10ft 6d.; finest quality push-back wire, 12 yards, 2/3; postage extra.—Post Radio Supplies, 33, Bourne Gardens, London, E.4. [3593]

**HENRY'S** offer:—T.R.F. medium and long wave coils with reaction, 80/6 pr with circuit; single pole eleven way, two bank switches, 4/6; 8mfd 450v wkg, 4/-; 8mfd 350v wkg, 2/3; 16x16mfd 350v wkg, 10/-; line cord 0.3 three-way 55ohms per ft, 3/- per yd; also 0.2 115ohms per ft, 3/- per yd; Rola 5in P.M. with transformer, 27/6; Goodmans 5in. less transformer, 21/6; Celestion 8in. less transformer, 21/-; Celestion amphenol valveholders, 4, 5 and 7 pin English, 4, 5 U.X. and int. octal 9d, each, 7/6 doz.; medium and short wave coils, aerial and oscillator, 465 K.C. 12/6, with complete ac/dc circuit; i.f. trans., small cans 465 kc. 7/6 each. **HENRY'S**, 5, Harrow Rd., Edgware Rd., London, W.2. [3656]

**RADIO SPARES**

**MAINS TRANSFORMERS**. Primaries 200/250 volts.

secondary 350-0-350 volts.	
Type A. 80 ma., 4v. 2a., 4v. 2 1/2a.	32/6
Type B. 80 ma., 6.5v. 5a., 6v. 2 1/2a.	32/6
Type C. 100 ma. Ratings as type A	34/6
Type D. 100 ma. Ratings as type B	34/6
Type E. 120 ma. Ratings as type A	37/6
Type F. 120 ma. Ratings as type B	37/6
Type H. 200 ma. Three L.T.s of 4v. and 4v. for rectifier. Ratings as required	47/6
Type I. 200 ma. Three L.T.s of 6.5v. and 5v. for rectifier. Ratings as required	47/6
Secondaries 500-0-500 volts.	
Type J. 200 ma. L.T. windings as type I	52/-
Type K. 200 ma. L.T. windings as type H	52/-
Type L. 250 ma. L.T. windings as type I	56/-
Type M. 250 ma. L.T. windings as type H	56/-
Secondaries 250-0-250 volts.	
Type N. 200 ma. L.T. windings as type H	47/6
Type O. 200 ma. L.T. windings as type I	47/6
Type P. 300 ma. L.T. windings as type H	60/-
Type Q. 300 ma. L.T. windings as type I	60/-
Secondaries 425-0-425 volts.	
Type R. 120 ma. 4v. 2a., 4v. 2 1/2a.	40/-
Type S. 120 ma. 6.5v. 5a., 6v. 2 1/2a.	40/-
Type T. 80 ma. L.T. windings as type R	35/-
Type U. 80 ma. L.T. windings as type S	35/-
Secondaries 425-0-425 volts.	
Type V. 120 ma. L.T. windings as type R	39/-

Types H to Q are provided with two L.T. windings, centre tapped.

Please note that owing to dimensions and weight of type H to Q, kindly add 2/6 for carriage and packing.  
**MULTI RATIO OUTPUT TRANSFORMER**, 120 ma. 15 taps, tapping for 6L6's in push-pull; P.K.'s in push-pull; low impedance triode; low impedance pentode; high impedance triode, 37/6; complete instructions with each unit.

**H. W. FIELD & SON**  
COLCHESTER ROAD, HAROLD PARK, ESEK

**THE AURI-PHONE**

A miniature Ear-  
phone with a high-  
fidelity reproduction  
of Speech and  
Music equal to best  
headphones known.  
1 1/16 inch diam.;  
holds in Ear without  
headband or  
wire loop. Two  
interchangeable  
nipples, large and  
small; two models, 10 ohms and 1000 ohms.  
Operate from prim. or sec. terminals of  
Speaker transformer, ideal for pocket radio,  
Valve or Crystal set. 5ft. flex cord. Price,  
black or flesh-colour enamel. 39/- Reg. Post  
free. **NOTE**: We do not make Deaf Aids.



Pat. pend.  
10525, 45

**CEFA INSTRUMENTS**, 38 1/2, York Street,  
TWICKENHAM, Middx. POFesgrove 6597.

**'SELECTEST'**  
is  
Coming

... will interest  
every Electrical  
and  
Radio Engineer.

**SALFORD ELECTRICAL INSTRUMENTS LTD.**  
PEEL WORKS . . . . . SALFORD 3

Now available for  
**LOW VOLTAGES**  
12v. and 24v.



**SOLON**  
Electric  
SOLDERING IRON FOR INDUSTRIAL USE

SOLON Industrial Type Electric Soldering Irons rated at 65 watts are now available for use where a low voltage system of supply is employed. There are two models, one fitted with an oval tapered bit as illustrated, the other with a round pencil bit, and they will do the same class of work as the well-known SOLONS of 65 watt rating for normal supply voltages.

Their design incorporates the many special SOLON features, including the fitting of the heating element inside the bit. Both models can be supplied fitted with elements for 12 volts or for 24 volts supply, as required. Complete with 6 feet of HENLEY twin core flexible. Write for details of the complete SOLON range of low and normal voltages.

W. T. HENLEY'S TELEGRAPH WORKS COMPANY, LIMITED,  
Engineering Dept., 51/53 Heston Garden, London, E.C.1

**ELECTROLYTIC CONDENSERS**

LASKY'S RADIO offer for sale the following condensers made by well-known manufacturers, new and tested:

8 mfd., 450 volt working, tubular	4/6
8 mfd., 550 volt working, tubular	4/6
8 mfd., 350 volt working, tubular	3/6
8 mfd., wet can type, 600 volt working	7/6
16 mfd., wet can type, 450 volt working	7/6
4 x 8 mfd. tub. cardboard, 450 volt working	9/9
4 mfd. block type, 650 volt d/c working	5/9
2 mfd. tubular, 600 volt	2/9
50 mfd. 12 volt biasing condensers	each 2/6
25 x 25 volt biasing condensers	each 2/6
.05 mfd., .02 mfd., .01 mfd. and .1 mfd., 400 volt working	1s. per doz.
P.M. Speakers.—Rola 5", less tran., 21/-; 6"; Rola, less tran., 22/6; 8" Rola, less tran., 23/6. 3" Goodmans, 3 or 15 ohm, v/coil, as required, 29/6; 5", less tran., 22/6; 6" Plessey, with, trans. power or pentode, 25/6; 10 and 12", prices on application.	
Volume Controls, all values, long spindle, with switch, 5/9, less, 3/6 Special type volume control for midgets 1/6, with switch, 5/9 each; few only.	
Tuning Condensers.—2-gang, as new. .0005 Midget with trimmers, 13/6, ceramic insulation; less trimmers, 10/6, all with fixing feet. Complete with slow motion drive and dial as required, m/w, m/w and 1, w, etc., 4/8 extra.	
Toggle Switches, all types, 2/6, 2/9 and 3/6 each. Hystoflex, all sizes, 2/6 to 3/6 dozen varies, best quality. Mains droppers, 2 and 3 amp., with fixing feet, 1,000 ohm, 6/6; 1,000 ohm, high gain, matched 5/6 pair, for T.R.F. long and medium wave coils, with circuit and reaction, 10/6 per pair. Cards of 36 assorted resistors, 1 watt, all useful values, 22/6; also 36 tubular condensers, carded, .0004 to 1 mfd., 22/6.	
TRANSFORMERS.—Mains standard 4 volt, 22/6, with feet; 6.3 volt, 32/6. Output types for speakers, midget pentode, 5/9; universal, medium size, 7/6; large pentode type, 9/6.	
Midget Smoothing Chokes, 500 ohm 60 m/a, 6/6. Line cord, .3 and .3 amp., 70 ohm per foot, 2 and 3-way, 3/11 yard, guaranteed.	
VALVES.—We have over 6,000 new, boxed and guaranteed B.V.A. valves in stock at list prices plus tax. Please send your queries. Send us your requirements. Terms, C.O.D. pro forma or cash with order. Send 1d. for price list of all goods.	

**LASKY'S RADIO**

364, 370, Harrow Road, London, W.9  
(Opp. Padd. Hospital) Tel. Cunningham 1979

C. A. RYALL, 36, Huron Rd., London, E.1 S.W.17.—Mail order only, no c.o.d. under £1 please; postage extra single items.

VOLUME controls.—Morganite 1/2meg with switch, long spindle, perfect job, 4/9; Morganite less switch, short spindle, 1/2meg, 2/9; Dubilier 1meg, spindle 2 1/2, 2/9; Centralab 1/2meg, 2/9; Morganite 10,000 ohm, 2/9.

CONDENSERS.—Tubular, 0.1 550v wkg, 7/6 dozen; 0.002 450v wkg, moisture proof, 5/6 dozen; pair 0.1 450v wkg, on pax. strip, new, 1/6; Mansbridge 4mf. baseboard, tags, terminals, perfect insulation, 250v wkg, 4/6. CELESTION 10in permanent magnet speakers with pentode transformer, powerful magnets, fine job; 35/-.

METER switches, 11-way, long spindle, new, take 1in behind panel, 4/6; push-back wire, c.c., waxed blue, 12 yds 1/6; 50 yds 5/6; knobs, brown, thimble pad, 1/4, 4/6 dozen; set five Clydeon 30mm trimmers on metal panel 1/6; Erie 1/2 watt insulated resistors, 330, 450, 10,000, 22,000, 220,000, 470,000, 2meg, 3/9 dozen; Morganite carbon coloured resistors, 500, 1,000, 50,000, 2meg, 3/6 dozen, 1/2 watt.

YAXLEY type switches, 3-bank, 2-pole, 4-way, with middle screen, long spindle, 4 short-circuiting bars, 4/9; Octal 8-pin plugs with metal cap, complete with chassis type socket, 1/3, 3 for 2/9; miniature 4-pin plugs with metal cap and socket, 3 for 1/6, 4/6 dozen; Octal 8-pin plugs with solder tags, complete with metal cap and sockets, 3 for 3/3.

VALVEHOLDERS, chassis type, our regular line, British 5- and 7-pin, American 1X 4-5-, 6-pin, and International Octal, all 4/6 dozen, 29/6 per 100.

MAINS transformers, 2500v 2ma, 2v 2a, 4v 1.4a, 230v prim., 30/-; ditto, but 2000v 2ma, 27/6; meters, gr. F.S., 0-1500v, 80/-; galvanometers, 500-0-500 microamps, 60/-; M.I. 600, 18/6, and other meters, all 21gin scale; resistors, 1/4, 1/2 and 1w carbon, wire ends, 50 asstd. for 10/6; vol. controls, 1 and 2 megs, 2/-; Yaxley switches, 3-way 5-bank, 6/-; Eddy-stone flex couplers, 1/-; Varley hf Nicore chokes, 1/6; condensers, fixed, variables, ganged, etc., in stock; s.a.e. list.—Heathcot, 24 Durnford Av., Urmston, Manchester. [4103

THE Simplex Four, complete constructional details of this most successful midget a.c.-d.c. receiver, total cost of construction 29/-, including theoretical and full-scale layout, wiring diagrams, with instructions, per copy, 4/6; midget cabinets, handsome design, in red or brown, 25/-; midget high gain m. wave, t.r.f. coils, 7/6 pair; midget m. and l. wave, t.r.f. iron core coils, adjustable cores, 12/6 pair; with circuit, aerial and oscillator coils, all-wave transformers, 15/- pair; midget i.t. transformers, circuit, 15/- pair; midget i.t. transformers, 45kc/s, 15/- pair; standard size ditto transformers, 12/6 pair; midget 2-gang 0.0005mfd variable condenser, with trimmers, 13/6; midget m. wave dials, 1/6; midget all-wave dials, in colours, latest station names, 4 x 3 1/2in, the best, 2/6; midget smoothing chokes, 50-60ma, 6/-; midget speaker trans., 6/6; medium chokes, 80 ma, 25hy, 9/-; heavy chokes, 120m, 25hy, 15/-; speaker tran., tapped output, 8/6; Rola universal p.p., 12/6; heavy duty output trans., for 6L6 valves, in p.p., 600ohms to a load, 7.5 and 15ohms output, 21/-; ditto driver split sec., 12/6; push button 6-way, with knobs, escutcheon, 5/6. We may have it, the chances are we have, consult monthly comprehensive lists, 2/6d. stamp with enq; postage all orders.—O. Greenick, 34, Bancroft Rd., Cambridge Heath Rd., London, E.1. S.W. 1334.

BATTERY charger kits, rectifiers, mikes, electrolytic transformers, metal rectifier, 2v 0.5a type with transformer, makes ideal trickle charger for 2v cell, with circuit, 13/6, postage 7d; metal rectifier, 12v 2.5a type, with transformer and ballast bulb for 2v to 12v charger, no ammeter or rheostat required, 47/6, postage 10d; also metal rectifier for 12v 2.5a charger, input volts 22v, 22/6, postage 7d; ditto 12v 4amp, 52/-; special charger kit for 6v car battery boots, ing. charges at 2amp, 37/6, post 10d; metal rectifier 12v 5amp type, with transformer, for 12v charger, 52/6, post 1/-; metal rectifier, 12v 1.5a type, with transformer and ballast bulb for 2v to 12v charger, 37/6, postage 10d, or supplied with Junior lamp rectifier, 32/6, rectifier alone 8/6, post 6d.

HEAVY duty type kits, weight over 17lb. metal rectifier, 12v 4amp type, with transformer for 6v-12v starter, 24, or with 5amp rectifier, 24/10; transformer, metal rectifier and ballast bulb for 3 to 20 cells at 1amp, ideal for small radio store, 25/10, guaranteed 1 year; transformer and metal rectifier for car battery boosting, 36v 5amp, tapped for 12v, 18v, 24v, £11, carriage 3/6, weights over 30lb. Rectifiers of all ratings available for conversion of valve type chargers to metal rectification, half-wave and centre-tap types, mnt types from stock.—Champion, 43, Uplands Way, London, N.21. Lab. 4457. [4035

**ELECTRADIX BARGAINS**

A selection from our large stocks METERS. D.C. Moving Coil Milliameters, 0-1 m.a., 100 ohms resistance, 2 1/2in. flush panel, bakelite case, 55/-; ditto, 0-1 m.a., 50 ohms resistance, 4 1/2in. flush panel, bakelite case, 80/-. Instrument Rectifier, 1 m.a., 10/6.

CIRCUIT BREAKERS. Ellison make mounted on sub-base, double pole O.L., 200 230 v A.C., single phase, 230 amps., 15in. x 13in. x 12in., weight approx. 50 lbs.; ditto, 300 amps, 17 1/2in. x 14in. x 15in., weight approx. 89 lbs. 220 v., 1,000 amp. S.P., 50 cy., D.P., with nd-volt hold-on coil, loose handle, switchboard mounting, oil switches, by Fergusson & Palin. All offered at very low prices to clear.

A.M. CUTOUPS on base, with bakelite cover, 4in. x 3 1/2in., D.C., 12 volts 40 amps., or 24 volts 40 amps., 35/- each.

BELLS. Tangent Ironclad bells, 230 50 volts A.C., 6in. gong, as new, 42/-. Klaxon and Secomak Super Horns, 230 50 volts A.C., in new condition, few only, 70/- each.

SWITCHES. G.P.O. Lab. Switches, D.P., fine job, up to 10 amps. reversing, 4in. base, 7/6. Knife A and E type, single pole C.O., 1/6. Double pole On-Off, 1/9. Double pole C.O., 2/6. 100 amp. S.P., with fuses, 22/6. 200 amps, 40/- 5 amp. ironclad tumbler, 2/9. Linked tumbler, 5 amps, 2/6. 10 amps., 3/2. Multi-contact R.I. 7-stud 5 amp. on ebonite panel, teak box base, 4 1/2in. x 4 1/2in., 7/6. Lucas 6-way lever handles, 4 1/2in. line with box back, 3/-; ditto, 8-way, 3/9. Rotary Hart snap switches, 2-way or On-Off, 10 amps., 4/-; 15 amps, 5/-.

BATTERY CHARGERS. "Lesdix" Nidday models, metal rectification, 2 volts 1/2 amp. for wireless cells, to large chargers for your car accumulator. Send for special Leaflet. "W."

H.T. MOTOR GENERATORS. 28 volt D.C. input, 570 volt, 160/200 m.a. D.C. output; small and compact enclosed machines, General Electric, £5 10s. Double current Dynamos, ex-R.A.F., 6 volts 5 amps. and 600 volt 80 m.a. ball bearings, weight 17 lbs., 37/6.

SMALL D.C. MOTOR GENERATORS by E. D. C. and others, for use with Receivers and Car Radio; take the place of H.T. Batteries. Drives off 12-volt accumulator and gives 230 volts D.C., 30 m.a. output, off 6-volt gives 110 volts 15 m.a. Originally made for Government radios. Two commutators, ball bearings, laminated field, insulated brush gear, covered armature windings. A splendid job, in new condition. 75/-.

NEW D.C./A.C. ROTARY CONVERTORS, U.S.A.-make, with smoothing units, 110/220 volts, 100 watts, £12; 110/110 volts, 100 watts, £10.

TRANSFORMERS. 3 kW. Crypto 230 v. to 115 v., shrouded, £12. 4 kW. Meewick 50 cy. 400 v. to 600 v., £9 10s. 500 watt Foster 50 cy. 440 v. to 110 v. 5 amps., £4 15s. 150-watt Foster 400 cy. 230 v. to 15 v. 10 amps., £2 15s. 5 watts H.T. test Transformers 110/220 v. to 1,000 v. 5 m.a., 10/-.

TRANSFORMERS, FOR REWIND 3 kW. New type with stampings 4in. x 6in. x 7 1/2in. Can be taken apart to make a number of smaller units. Weight with damaged wire is 65 lbs. Limited number at 45/-, carriage extra.

BUTTON MICROPHONES are SOUND TRANSMITTER UNITS. A marvel of acoustic engineering design, as used by G.P.O. For amplification and detection of sound for all purposes.

EVERY BUTTON GUARANTEED. The lin. dia. brass body forms the granule chamber and the diaphragm is thin mica. Needs only a pocket battery 4 1/2 volts and a high ratio transformer. With special transformer and instructions, 7/6. Button only, 2/6.



MIKES. Tannoy Hand Mike multi-cell Carbon type for announcers, Broadcasters, and Recorders. The very thing for your Sports Meeting or Dance Hall; weatherproof, with switch in handle, 21/-.

Please include postage for mail orders.

**ELECTRADIX RADIOS**

214, Queenstown Road, Battersea, London, S.W.8  
Telephone: MACaulay 2159

**THE STATIC  
CONDENSER  
Co. Ltd.**

★ *Manufacturers of  
STATIC  
CONDENSERS*

**TOUTLEY WORKS,  
WOKINGHAM,  
Berks.**

'Phone: WOKINGHAM 708

**YOU  
can become  
a first-class  
RADIO  
ENGINEER**

We are specialists in Home-Study Tuition in Radio, Television and Mathematics. Post coupon now for free booklet and learn how you can qualify for well-paid employment or profitable spare-time work.

**T. & C. RADIO COLLEGE**  
North Road, Parkstone, Dorset

(Post in unsealed envelope, 1d. stamp.)

Please send me free details of your Home-Study Mathematics and Radio Courses

NAME .....

ADDRESS .....

W.W.43

**CHARLES BRITAIN RADIO** (K. H. Edl) offers new and used bargains this month. MAINS transformers, 350-0-350v, 4 or 6v heaters, shrouded type, with mains tap in top, used but perfect, £1 ea.; steel chassis, size 10½x8x2½in, drilled 5 valves and hole for trans., 2/- ea.; ast'd resistances, stripped from Ekco chassis, all useful values, 3/6 doz.; ast'd mica condensers, new and used, various makes, 3/6 doz.

THE following components are new and in perfect condition: All-wave aerial coils and oscillator coils covering all bands, long, medium and short, with circuit diagram, 14/- per set; trf coils, short and medium, with trims., 10/- pr.; P type coils, medium wave only a, oac and hf, 2/- ea.; 2-gang condensers with trims., 12/9 ea.; if transformers, Litz wound iron cores with trims. and all trims., 12/6 pr. (465k/c); Amphenol valve holders, Int. octal or British octal, 7/6 doz. THIS month's special offer: Small moving coil mikes, can be used as tweeters, etc., 3/6 ea.; or slightly damaged, 2/- ea.; send for our new list; terms, cash or c.o.d. over £1.—Charles Britain Radio, Radio House, 2, Wilson St., London, E.C.2. [4023]

**TELE-RADIO** (1943), Ltd., for new components at list prices. Precision sub-standard condensers, 1% accuracy, 0.0001mfd 37/6, 0.001mfd 18/-, 0.01mfd 21/-, 0.1mfd 27/9, 1mfd 45/-; wirewound precision resistors, Weston meter, 0-250 micro amps, centre zero, £3/5; C.R. tubes, Keaton mains transformers, chokes and output transformers, instrument wave-change switches, 2-gang condensers with sm drive, 16/9 ea.; Vitavox and Celestion speakers; specialists in short-wave work; new list ready shortly; send stamp.—Tele-Radio (1943), Ltd., 177, Edgware Rd., London, W.2. 'Phone: PA. 6116. [4086]

**COUPLPHONE RADIO**, Station Rd., New London, nr. Preston.—New goods only of the highest quality; all orders attended to same day as received; note price reductions on many lines, and remember that all orders over 5/- are post free; goods now sent c.o.d.: electrolytics, 8x450v 6/6, 8x8 450 12/6, 2x350 3/6, 25x25 and 50x12 2/6, 25x50 3/-, 50x50 3/3; Rola, Plessey, Goodmans and Celestion speakers, p.m., less trans., 3½in 29/-, 5in 21/-, 6¼in 21/6, 8in 22/6, 10in 35/-, with trans., 6¼in 27/-, 8in 27/6, 10in 42/6; Vitavox super quality, 12in p.m. K12/10, £6/13; Rothermel Senior de luxe crystal pick-ups, £3/18/9; mains transformers, screened primary, 200-250v, 350-0-350, 100ma, with 4v or 6v l.t.s. 26/6; bobbins only, 15/6; 420-0-425, 200ma, 4v 8a, 4v 4a, 4v 4a or 6.3v 4a, 6.3v 4a, 5v 3a, 47/6; 20hy 200ma chokes, heavy duty, 21/-; speaker transformers, push pull universal types, 4watt 8/6, 8w 12/6, 15w 21/-, 30w 37/6; Midget pen, 5/-; dropper resistors, 800Ω 0.3a, with feet and two sliders, 4/6; push-back wipers, 50ft 2/9, 100ft 4/9; Delaflex 2mm sleeving, 2/- dozen; valve-holders, 5-, 7-, 9-pin English, Mazda octal 4-, 5-, 6- 7-pin UX and Int. octal, all types 6d. each; resin cored solder, 4/- lb.; 3-way cable, 6d. yd, 5-way 10d.; line cord, 60ft per foot, super quality 2- or 3-way, 3/6 per yd; Centralab vol. controls, all sizes, less sw. 3/6, with sw. 4/9; s.a.e. for comprehensive list.

**WANTED, EXCHANGE, ETC.**  
I L5S and ILN5 valves, qty. 1 each.—BM/DNIH, London, W.C.1. [4056]  
WTD, single-tap new aerial filter and other components.—Box 3395. [4129]  
WTD, ht vibrator with 7-pin American type base, 12v.—Box 3347. [4081]  
WTD, Aeco (Permarec) 2 sp recording motor, imperfect mod. considered.—Box 3391.  
CONVERTER wanted for 100v dc to anything between 100-250 ac.—Box 3049.  
WTD, Avc valve tester and oscillator, also 100w dc-ac converter.—Write Box 3357.  
WANTED, oscillograph, Dumont 208 or Consor 339; any condition.—Box 3356.  
WANTED, one valve 701.7 CF amplifier and rectifier.—Price to Griffin and Tatlock, Ltd., Kemble St., Kingsway, London, W.C.2.  
WANTED, static and rotary converters, all sizes; also small transformers, all ratios. H. H. HYWOOD, Elect. Eng., 18, Coram St., London, W.C.1. [3991]

WE buy for cash, new, used, radio, electrical equipment all types; especially wanted, radios, radiograms, test equipment, motors, chargers, recording gear, etc.—If you want to sell at the maximum price, call, write or phone to University Radio, Ltd., 22, Lisle St., Leicester Square, W.C.2. Ger. 4447.

**REPAIRS AND SERVICE**  
BEST quality rewind in 24 hrs.; guaranteed; competitive.—Radiowinds, Brundall, Nfk.  
REWINDS and conversions to mains and output transformers, fields, etc., from 4/6.—N.L. Rewinds, 4, Brecknock Rd., N.7. [3915]  
MAINS transformers rewound and constructed to any specification; prompt delivery.—Brown, 3, Bede Burn Rd., Jarrow. [3460]



**ELECTRICAL AND RADIO ENGINEERS' OHM'S LAW CALCULATOR**

Whether you are constructing, or servicing a radio set, problems involving voltage, current and resistance can delay progress.

Flik-o-Disk will give the answer in a jiffy. For example, what resistance should you use to obtain a voltage drop of 100 v. when current equals 30 m.a. ? A flick of the disk and there is your correct answer—3,000 ohms. The scales read from 1 millivolt to 1,000 volts. From 1 ohm to 1,000,000 ohms. From 1 milliamp to 10 amperes. From 1/10th of a milliwatt to 10,000 watts.

The calculator is sold complete and with full instructions at Radio Stores and Stationers. If unable to obtain, write to **IONIC LABORATORIES LTD.**, Dept. W., Cranbourne Terrace, SALT HILL, SLOUGH, BUCKS, for name and address of your nearest stockist.

PRICE **6/6**

**INSTRUMENT WIRES, ETC.**

Gauge, covering and continuity guaranteed. 14-16-18-20-22-24-26-28-30-32-34 swg. enam. 2/9, 3/-, 3/3, 3/6, 3/9, 4/-, 4/3, 4/6, 4/9, 5/-, 6/- per lb., smaller quantities reels 2d. extra. 1- to 3-lbs. reels, 1/- extra. 4- to 8-lbs. reels, 2/6 extra. All reels returnable. Also many other interesting Radio and Electronic items. Lists, 1d. S.A.E. Orders over 30/- post free.

**MIDLAND INSTRUMENT CO.,**  
18, HARBORNE PARK RD., BIRMINGHAM, 17.

**THESE ARE IN STOCK**

- CLASSIFIED RADIO RECEIVER DIAGRAMS. By E. M. Squire. 10/6. Post 4d
- WORKED RADIO CALCULATIONS. By Alfred T. Wills, A.M.I.E.E. 6/6. Post 3d.
- NEWSIES TELEVISION MANUAL. By P. J. Camm. 6/- Post 4d.
- RADIO RECEIVER DESIGN. Vol. I. By K. R. Sturley, Ph.D., B.Sc., M.I.E.E. 28/- Post 7d.
- "ELECTRICAL ENGINEER'S" REFERENCE BOOK. Edited by E. Molloy. 42/- Post 10d.
- RADIO VALVE DATA POCKET BOOK. By F. J. Camm. 5/- Post 2½d.
- VALVE REPLACEMENT MANUAL. For Radio Service Engineers. By A. C. Farnell & Arthur Woffenden. 6/- Post 3d.
- THE WIRELESS WORLD VALVE DATA. Operating conditions and base connections of the principal types and makes. 2/- Post 2d.
- CATHODE-RAY OSCILLOGRAPHS. By J. H. Reyner, B.Sc. (Hons.), A.C.G.I. 8/6. Post 4d.

WRITE OR CALL FOR COMPLETE LIST, 1d.

**THE MODERN BOOK CO.**  
(Dept. W.4), 19-23, PRAED STREET,  
LONDON, W.2.

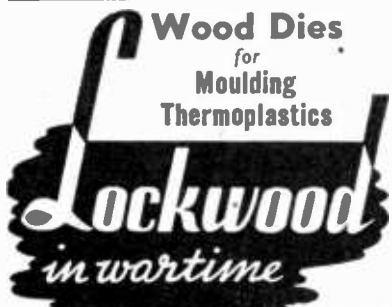

Wood Dies  
for  
Moulding  
Thermoplastics

**Lockwood**  
in wartime

No. 4

1938-1945

During this period "Lockwood" craftsmanship has been utilised in connection with the following famous aircraft:

ALBACORE, ANSON, BARRACUDA, BATTLE, BEAUFORT, BEAUFIGHTER, BLENHEIM, BOA, DEFIANT, FULMAR, GLADIATOR, HAMPDEN, HALIFAX, HURRICANE, LYSANDER, LANCASTER, LINCOLN, MILES MASTER, MARTINET, MONITOR, MAGISTER, MANCHESTER, MOSQUITO, MUSTANG, OXFORD, ROC, SUNDERLAND, STIRLING, SEAFIRE, SPITFIRE, TYHOON, TORNADO, TEMPEST, THUNDERBOLT, WELLINGTON, WELLESLEY, WELKIN, WHIRLWIND, YORK, Etc.

When circumstances permit we shall again make beautiful Cabinetwork and Furniture

**LOCKWOOD & COMPANY**  
HARROW, MIDDXX. BYRON 3704

**AS PROMISED**

In last month's advertisement, we now have pleasure in giving you extracts from letters sent in by CANDLER students who are taking the **ADVANCED Code Course**.

**10 DAYS.** "I am just completing lesson 2. . . it is just 10 days of training, and I feel I am rapidly progressing with receiving and quickly getting rid of my old habits in handling the key."  
Ref: 1875. K. B. S.

**10 DAYS.** "You will no doubt be pleased to hear I passed my advancement examination with an excellent percentage after only 10 days study on lessons 1 and 2."  
Ref: 1621. R. R. E.

**4 LESSONS.** "I am highly satisfied with my progress so far; my speed has increased more in the past month with Candler Training than with 3 to 4 months ordinary training; the results have amazed my fellow wireless instructors here in the depot."  
Ref: 1904. W. H.

**"SPEED."** My speeds are now: Reading, 28 w.p.m.; Copying (Pen), 24 to 25 w.p.m.; Sending, 27 to 28 w.p.m. So far, copying behind, only 2 or 3 letters, but I must say I have noticed a great improvement, and I am quite satisfied in the results of my training so far."  
Ref: 1894. N. G. T.

These students are taking the **ADVANCED Code Course**. The original letters of above students and of those quoted in last month's advertisement, see page 28, may be inspected at the London Office. If you have not had a copy of the Candler "BOOK OF FACTS" (Free on request), send for one now. It gives all details of the Candler Code Courses for Beginners and Operators.

Code Courses on Cash or Monthly Payment Terms.  
**THE CANDLER SYSTEM CO.**  
(Room 55W), 121 Kingsway, London, W.C.2  
Candler System Co., Denver, Colorado, U.S.A. (104)

**L** OUDSPEAKER repairs, British, American, any make; moderate prices.—Sinclair Speakers, 12, Pembroke St., London, N.V.1. Terminus 4355.

**A** CCURATE radio rewinds, mains transformers, fields, op. transformers, etc.—Southern Trade Services, 297-299, High St., Croydon. [3971]

**M** ETROPOLITAN RADIO SERVICE CO. for guaranteed repairs to British and American receivers of all types.—(Service Dept.). 1021, Finchley Rd., N.W.11. [3886]

**48** -HR. rewind service; trans, chokes, fields, outputs, clock coils, pick-ups, vacuum motors repaired; guar. work; comp. prices.—Groves, 154, Ickneild Port Rd., B'ham, 16.

**R** ADIO repairs quickly executed to all makes, English or American; lowest possible prices.—The Music Box, 89, London Rd., London, S.E.1. (Tel. Waterloo 4460 and 6766.)

**A** LL types of radio receivers serviced; Murphy and Pilot specialist; valves in stock; sound repairs for 13 years.—T. E. Peveyer, F.I.P.R.E., 50, Vine St., Uxbridge.

**M** AINS transformers service, repairs, rewinds, or construction to specification of any type, competitive prices and prompt service.—Sturdy Electric Co., Ltd., Dipton, Newcastle-upon-Tyne. [3084]

**"S** ERVICE with a Smile."—Repairers of all types of British and American receivers; coil rewinds; American valves, spares, line cord.—F.R.I. Ltd., 22, Howland St., W.1. Museum 5675. [1575]

**T** RANSFORMER rewinds, special designs manufactured, all types fields, chokes, outputs, etc.; moderate charges, quick delivery, guaranteed high-class work; trade only.—H. W. Forrest, 67, Burman Rd., Shirley, Birmingham. Shl. 2485. Est. 1922. [3652]

**24** -HOUR service—6 months' guarantee, any transformer rewind, mains, outputs and i.f.s., etc.; all types of new equipment supplied to specification; business heading or service card for trade prices.—Majestic Winding Co., 180, Windham Rd., Bournemouth. [3592]

**R** EWINDS, mains transformers, field coils, chokes, high-grade workmanship, 7-day delivery; new transformers constructed to customers' specification, singly or in quantities.—Metropolitan Radio Service Co., 1021, Finchley Rd., N.W.11. Speedwell 5000. [3719]

**T** O radio dealers and service engineers only—Loudspeakers, repaired quickly, or materials supplied; also big stocks of all components; send your trade card or billhead and 1d. stamp for our current lists.—A.W.F. Radio Products, Borough Mills, Sharpe St., Bradford, Yorks. [3410]

**R** EWINDS.—Repairs to moving coil speakers, cones, coils fitted, fields wound or altered, mains transformers, eliminators and clock coils rewound; competitive prices; speaker transformers and pick-ups repaired, 4/6 each; post free; guaranteed satisfaction; prompt service.—I.S. Repair Service, 49, Trinity Rd., Upper Tooting, London, S.W.17.

**D** EGALLIER'S, Ltd.—"Service with a guarantee." If you cannot get your receiver serviced let American specialists do the job; first-class workmanship only; specialising in Air-King, Belmont, Challenger, Detroit, deWald, Emerson, Ferguson, Gard, Haliorafter, Hamerlund, McMurdo, Medwest, Majestic, Pilot, Philco, Spartan, etc., also any British set. Remember, for 15 years we have handled as distributors American receivers; a.s.e. with all enquiries.—Degallier's, Ltd., 9, Westbourne Court, London, W.2.

**MISCELLANEOUS**

**S** PARKS' data sheets.—These data sheets provide complete constructional details, together with full-size 'prints, etc., of tested and guaranteed designs.

**E** LECTRIC guitar units (3rd edition), 5/-; **E** LECTRONIC one-string fiddle, 3/6; 6-8 watt a.c./d.c. amplifier; phase inverter; push-pull output; neg. feedback; portable for use with above or mike, p.u., etc., 3/6; **A** .c. two-valver, med. wave, coil details, 2/6; **3** 1/2 watt ac amplifier, 2/6.

**S** PARKS' DATA SHEETS (W.), 9, Pheobeth Rd., Brockley, London, S.E.4. [3622]

**C** HASSIS, brackets, clamps, shrouds, etc., made quickly, accurately with professional finish in A.A. benders, used by large radio mfrs., invaluable to experimental engineers.—Full details free from A.A. Tools, 197a, Whiteacre Rd., Ashton-u-Lyne. [3770]

**SITUATIONS VACANT.**

None of the vacancies in these columns relates to a man between the ages of 18 and 50 inclusive or a woman between the ages of 18 and 40 inclusive unless he or she is excepted from the provisions of the Control of Engagement Order, 1945, or the vacancy is for employment excepted from the provisions of that Order.

**A** MPLIFIER equipment manufacturers require charge hands for inspection and checking; well experienced.—Box 3350. [4091]

**M. WILSON LTD**  
(late Austerity Radio Limited)

**Circuit No. 19**  
**MIDGET SHORT-WAVE CONVERTER**  
12-35, 34-100, 91-261 metres. Triode hexode. F.C. International Octal valve. Can be fitted to any standard receiver. Battery, A.C. or A.C./D.C. Full specification on application. State type required.

**GRAMOPHONE AMPLIFIER CHASSIS.** Assembled on chassis fitted with separate tone-control. Volume control with on/off switch. Sockets for microphone, gramophone and extension speaker. Hum-free, good quality reproduction. A.C. only. Input 200/250v. Size overall 8 x 6 x 7 1/2 in. Ready to play. Prices include valves and speaker

4 valve, 4 watt	10 gas.
4 valve, 6 watt, with PX4 output	12 gas.

Theoretical and practical blueprints and list of parts for the above available separately, 3/6 per set of 3.

**BLUE PRINTS** of the following Circuits (1 Theoretical and 3 Practical), 3/6 per set —

- No. 1: A.C. T.R.F. 3 valves. Medium-wave only.
- No. 2: A.C. T.R.F. 4 valves. Long, Med., and Short.
- No. 3: A.C. T.R.F. 4 valves. Short-wave only.
- No. 6: A.C. Superhet. 4 valves. L, M and Short.
- No. 8: A.C./D.C. Superhet, 4 valves. L, M and S.
- No. 7: Battery T.R.F. 3 valves. L, M and S.
- No. 8a: Battery 4-valve Superhet. 3 wavebands (16-50, 200-537 and 700-2,000 metres). 1.4v valves. (Tropical or non-tropical.)
- No. 9: Battery T.R.F. 3 valves. Short-wave only. Priced list of parts sent with each set of blueprints.
- No. 17: A Small Communication Type A.C. Superheterodyne Receiver. Brief specification: 6 wavebands, 6-2,000 metres, Radio-Frequency stage, 7 valves Int. Octals, including beat frequency oscillator and rectifier. 46k/cs. Blueprints, 5/- per set of three.
- No. 18: A.C./D.C. version of the above. Blueprints 5/- per set of three.

**M** AINS TRANSFORMERS. To suit all circuits built to specification.

**WESTECTORS.** WX6, 4/- each.

**U** LTRA-SHORT-WAVE COILS (plug-in), air-spaced, silver copper wire R.F., H.F. and Osc. range 1, 4.5-8 metres; range 2, 9.5-17 metres. 2/3 each. 6/6 per set of three, with circuits.

**T** OGGLE SWITCHES. Miniature on/off, single pole. 2/6. D.T., D.F., 4/3.

**M** ETAL RECTIFIERS. Small, chassis mounting, 45 volts. 40 m.a. 7/6 each.

**C** HASSIS. Battleship-grey sprayed. Undrilled, 10 x 8 x 2 1/2 in., 7/6. 8 x 6 x 2 1/2 in., 4/6.

**S** .W. TUNING CONDENSERS. .00015 twin-gang mounted on ceramic base, 12/6. 3-gang, .0005 ceramic insulation, 12/6.

**F** lexible Couplers, 1in., 1/- each.

**T** rimmers. Ceramic base 70 pf. 3-bank, 2/3. 2-bank, 1/6. Single, 9d. Padders, 500/500 pf., 2/6 each.

**D** .C.C. Wire. Gauges 16 to 36, 1/6 to 4/- per lb. reel. Enamelled copper wire, 16 to 32, 1/2 to 2/3 per lb.

**B** rown Bakelite Knobs. Round, 1 1/2 in. (to fit 1/2 in. shaft). 9d. each

Look out for our  
Special Television  
announcement

**TO OVERSEAS TRADERS**

Wholesale and retail enquiries are invited.

Orders can be executed for B.A.O.R., C.M.F. and S.E.A.C. customers.

**307, HIGH HOLBORN.**  
LONDON W.C.1. Phone: HOLborn 4631

# AMPLIFIERS

LATEST MODEL A20



Price £14.0.0

Complete kit of parts ready to assemble  
(If wired complete and tested £15.10.0)



Output—two 6V6's in P.P. with cathode coupled phase changing using 6J5's. First stage 6J5, rectifier 5Z4.

Complete with carrying case.

Write for further details and lists

## RADIO INSTRUMENT CO.



Radio Products  
294, BROADWAY,  
BEXLEYHEATH, KENT

## BERRY'S (SHORT WAVE) LTD.

A MOST COMPLETE  
LIST W.W.

## RADIO & ELECTRONIC EQUIPMENT

will be sent on receipt  
of stamped envelope

25, HIGH HOLBORN, LONDON, W.C.1  
(Tel: HOLborn 6231)



## W. BRYAN SAVAGE LTD.

Expert assistance in the solution of  
problems relating to

- TRANSFORMERS, CHOKES
- AMPLIFIERS
- POWER UNITS

and Specialised Equipmen-  
embodying

ELECTRONIC CONTROL

WESTMORELAND RD., N.W.9  
COLINDALE 7131

**BROMLEY**.—Exp. service engineer, radio, television; gd. wages; perm.—Box 3345.

**EXPERIENCED** radio service engineer, re-  
quired, good salary, progressive firm.—  
Halford-Thompson and Co., Tavistock, Devon.

**TRACER** (female) required in drawing office  
of electrical firm in S.E. London.—Write,  
stating qualifications, experience, salary re-  
quired and when available, to Box 3339. [4071]

**RADIO** engineers required for production and  
development by manufacturer's Midland  
factory, Class A ex-Servicemen.—State age, ex-  
perience and salary required to Box 3052.

**SOUND** equipment engineers required for  
testing, analysis and fault finding on  
production tests of high-grade amplifiers;  
good prospects; central London.—Write with  
details of experience, Box 3351. [4092]

**SMALL** progressive manufacturers in the  
Midlands require radio engineer, experi-  
enced in the design and production of radio  
and p.a. equipment.—Write stating experience  
and salary required, Box 3342. [4074]

**AMPLIFIER** engineer required with thor-  
ough knowledge of sound-on film repro-  
duction; applicant must be prepared to de-  
sign new types and service existing models.—  
Write, stating experience and salary required,  
Box 3145. [4057]

**CHARGE** hands required for radio and/or  
electrical instrument servicing; class A  
Servicemen or men over 51; must be experi-  
enced, not afraid of work, conversant with  
modern methods; good wages and perman-  
ency.—Box 3500. [3629]

**LIVE** radio service engineers wanted imme-  
diately, accustomed to fault finding,  
checking, testing, etc.; good wages; Slough  
district; permanent post for suitable men, over  
51 or Class A ex-Servicemen; unless fully  
qualified do not write.—Box 3515. [3670]

**RADIO** engineer required immediately for  
Rugby; must be first-class man (capable  
of servicing Murphy, Bush, H.M.V., and all  
the best makes of radio) and taking control  
of service dept.; permanent post and pleasant  
working conditions.—Write, stating full de-  
tails and wages required, Hansons, Ltd., 48,  
Church St., Rugby. [4050]

**CHIEF** draughtsman.—Experienced and com-  
petent draughtsman to take charge of  
drawing office of firm in S.E. London, specialising  
in light and mechanical equipment, includ-  
ing small electric machines.—Write, stating  
qualifications, experience, salary required, and  
when available, to Box 3338. [4070]

**RADIO**.—Interesting and well-paid jobs as  
resident service engineers in various parts  
of the country are available now to radio and  
radar mechanics released from the Forces;  
Transport and all equipment provided; men  
particularly needed for London, Birmingham,  
Leeds, Manchester, Newcastle and Glasgow.—  
Box 3150. [4062]

**LEADING** electrical company has vacancies  
for number of salesmen, 25-40 years of  
age, in London and Provinces; good know-  
ledge of radio valves and their application  
essential; men with knowledge of radio cir-  
cuits and experience of maintenance of radio  
sets and who are due for early release should  
apply to Box 3341. [4073]

**RADIO** engineer required for receiver de-  
velopment work, must have good previous  
experience and qualifications up to I.E.E.  
standard; progressive appointment with well-  
known organisation.—Write, giving full details  
of experience, qualifications, and salary re-  
quired to Box 7660, A.K. Advg., 212a,  
Shaftesbury Ave., W.C.2. [4066]

**RADIO** draughtsman required to start new  
contract, important priority; must have  
good knowledge of radio technique, preferably  
in receiver design, and if possible some know-  
ledge of miniature technique; opening presents  
good opportunity for man with initiative, Class  
A ex-Serviceman.—Write, stating age, experi-  
ence and salary required, to Box 7601, A.K.  
Advg., 212a, Shaftesbury Ave., W.C.2. [4044]

**ELECTRONIC** equipment for industry.—Re-  
quired by well-known firm in S.E. Lon-  
don, engineers with good basic knowledge and  
development initiative for designing, supervising  
construction and installation special con-  
trol equipment; applications can be considered  
from Class "A" ex-Servicemen or men over  
51.—Write, stating qualifications, experience,  
salary required and when available, Box 3337.

**RADIO** mechanics instructor.—Government  
Training Centre, Letchworth. Good  
practical experience, particularly on commer-  
cial radio sets, essential; salary £300 per  
annum, plus Civil Service war bonus (at pre-  
sent £60 per annum), 44 hours per week,  
annual leave at the rate of 12 days per annum  
at full pay and, after 3 months' service, sick  
leave with pay under usual Civil Service con-  
ditions.—Apply M.O.L. and National Service,  
Employment Exchange, Letchworth. [4110]

# WANTED

## Agent — Distributors

Parmeko Ltd. of Leicester intend to  
appoint agents for selling, distribution  
and servicing of Parmeko sound  
reproducing equipment in areas  
throughout the country. Applications  
are invited from established firms with  
staff for large wiring installations of  
factories and public buildings. A good  
trading reputation and wide connec-  
tions and experience in this type of  
work are essential.

The equipment is designed for:—

- |   |                    |
|---|--------------------|
| INDUSTRY ('Music while you work,' Paging, Fire Alarm, etc.) | SCHOOLS            |
|   | THEATRES           |
|   | HOTELS             |
| PUBLIC BUILDINGS  | SPORTS EVENTS, Etc |

Full details to X.1 Department:

## PARMEKO

AYLESTONE PARK, LEICESTER

For **UTMOST PRECISION**  
always use

**DEFAM** ELECTRICAL INSTRUMENT COMPANY LIMITED  
TORQUAY DEVON

## Radio Servicemen

How would you like: (a) to receive a monthly ration of 12 electrolytics? (b) to be able to borrow receiver service sheets? (c) to be able to get practically any valve or spare? (d) to receive an interesting bulletin fortnightly? All these and other advantages cost you nothing! One condition only: you must be running a regular spare or full-time radio repair service. Write enclosing 7/6 requesting to be made a member of V.E.S.

V. E. S. (W), Radio House, Ruislip, Middx

## R. A. ROTHERMEL LTD

are now able to supply their well-known Pleso Crystal Products, including:—

- PICK-UPS, MICROPHONES, HEAD-  
PHONES, NEEDLE PRESSURE UNITS.

Descriptive leaflets and prices on application.  
ROTHERMEL HOUSE, CANTERBURY  
ROAD, LONDON, N.W.4.

## Why not try a "PULSATRON"

### COLD CATHODE GAS FILLED DISCHARGE TUBE

for

Square Wave Generation,  
Amplitude Limitation, Etc.

Write for particulars.

— NO CALLERS —

F. J. G. VAN DEN BOSCH  
10, Palace Mansions, London, W.14



**DIPLOMA**  
**AT THE**

*The Latest Achievement*  
**ALL THE LATEST ACHIEVEMENTS IN STOCK (EXCEPT ABOVE)**

British Physical Laboratories' made: Universal Test METERS, ranging 10,100, 500 v. at 1,000 ohms per v. A.C. D.C. 1,10,100,500 mA/DC, 0-10,000 ohms. Full scale deflection, toughened glass, bakelite case, leather handle, 23 lbs. Also Moving Coil Milliammeters and Microammeters, 51/-, 58/-, 68/-, 19 8. Testoscopes, 37/6. Flikodisk, 6/6. Trimmer Tool Kits: 12 assorted Box Spanners and Screwdrivers, w/2 extensions in wallet, 30/-. A.C. Eliminators, 300/250 input, 25 ma output, 1A, 120 v., 100 v., 75 v., 60 v., crystalline case, 47/6. Car Aerials, telescopic, nickel plated, 21/-. Soldering Irons (state voltage), 13/6: Universal Model, 22/-. Speakers, 8" less tr., 23/-; 6" with tr., 27/-; 3" less tr., 30/-. Line Cord, 2 way, 3 60 ohms per foot, 1/-; 3-way, 3 60 ohms per foot, 1/1; 3-way 15 100 ohms per foot, 1/2. Vibrators, 4-pin 6 or 12 v., 21/-.  
I.F. Ganged Coils, 465 k/c., pair 16/3. Universal Mains Sockets, 4/6. Trf. Coils, w/diagram, pair 9/6. Resistors, variable Mains dropping, 2 or 3, 5/6. In cage, 11/8. Cards of 36 ass. resistors, 1 watt, 27/6; 1/2 watt, 24/-. Volume controls with switch, 6/-. Speaker transformers, pentode and power, 6/9. Universal model, 9/6. 3-gang Condensers, 12/6; 2-gang, 15/6. And many other lines.

**RADIO LITERATURE**

Television, 1/- Test Gear Reconstruction, 1/6. Amplifier Manual, 2/-. Equivalents Charts, 1/7. Manual of Circuits, 2/-. Short Wave Handbook, 2/-. American Midgets, 2/7. Essential Valve Data, 2/7. Wireless Terms Explained, 3/-. Manual of Br. and Am. Valves, 3/8. Radio Inside Out, 4/6. Radio Simplified, 4/6. Basic Radio, 5/-. First Course in Wireless, 5/-. Introducing Radio Servicing, 6/-. Receiver Circuits Book, 6/-. Various Service Sheets, dozen, 10/6. Various Service Diagrams, dozen, 7/6. Giant World Radio Map, 5/-. Classified Diagrams, 10 6.

**VALVES**

Mullard, Marconi, Eveready, Magda, Consor, Brimar, Philips, Ferranti, Orram, Tungsram, Hvac. Also American Midgets and Acorns. If exact valve or equivalent not in stock, we can supply valve and adaptor as replacement; add. cost, 4/6. Please order C.O.D. Under 10/- C.W.O. 2hd. stamp with enquiry.

**EXPORT ORDERS INVITED.**

**J. BULL & SONS**  
(Dept. W.W.)  
246 High St., HARLESDEN, N.W.10

**'ENGINEERING OPPORTUNITIES'**

This unique handbook shows the easy way to secure A.M.I.Mech.E., A.M.Brit.I.R.E., A.M.T.E.E., City and Guilds, etc.

**WE GUARANTEE— "NO PASS—NO FEE."**

Details are given of over 150 Diploma Courses in all branches of Civil, Mech., Elec., Motor, Aero., Radio, Television and Production Engineering, Training, Building, Govt. Employment, R.A.F. Maths., Matriculation, etc.

Think of the future and send for your copy at once—FREE.

**B.I.E.T., 107, SHAKEPEARE HOUSE, 17, STRATFORD PLACE, LONDON. W.1.**

**WORKING manager** required by small company employing 60-70 hands in electrical department; must have first-class knowledge of small induction coil winding and test gear, also light assembly work; good salary and percentage profits; N.W. London.—Box 3343.

**CHIEF engineer** required by important South London manufacturing firm to take charge of works laboratories; candidate should have good academic qualifications in scientific and engineering field and have specific knowledge of R.F. and A.C. engineering; previous first-class administrative ability essential; the position carries considerable scope and good salary.—Full details to Box 3149. [4061]

**RADIO engineer** required to take charge of receiver development work of an established company; an opportunity for a young man with B.Sc. or equivalent, and possessing knowledge of pre-war receiver design.—Write, giving full details of experience, qualifications and salary required, to Box 7655, A.K. Advg., 212a, Shaftesbury Ave., W.C.2. [4067]

**A COUSTIC design and production engineers** required by firm in S.E. London, sound knowledge of basic principles underlying microphones, pick-ups, amplifiers, loudspeakers, essential; applications can only be considered from Class "A" ex-Servicemen, or men over 51.—Write, stating qualifications, experience, salary required, when available, Box 3336.

**THE Murdoch Organisation** have a number of vacancies for first-class radio service engineers as soon as the relevant restrictions are removed, in branches covering various parts of the country.—Applicants should have had previous proved experience of servicing domestic radio, and should apply in writing in the first instance, giving full details of experience and salary required, to Staff Manager, Murdoch, 21-27, Lamb's Conduit St., London, W.C.1. [4051]

**2 DEVELOPMENT engineers** required by radio test gear and communications equipment and component manufacturers; one must be experienced in the design and development of modern test gear and communication equipment, and the other on radio components for the above and associated apparatus; state pre-war and wartime experience in full.—Date available and salary required to Box 3397. [4131]

**SITUATIONS WANTED**

**ARTIST-DESIGNER**, specialised in modern cabinet design, seeks contact with radio manufacturer.—Write Box 1135. [3972]

**SPECIALIST** in radio frequency heating seeks firm manufacturing or intending to manufacture equipment.—Box 3403. [4111]

**SERVICE engineer**, 17 years' experience all types of communication equipment, C. and G. certificates; demobilisation from R.A.F. November.—Box 3395. [4128]

**ARMY officer**, 34, 18 years' experience in electrical, radio, and mechanical engineering, prior to war in charge experimental workshop (television); free Oct.—Box 3147.

**EXECUTIVE**, several years' experience in general management, knowledge export and languages, requires responsible post where initiative, knowledge count.—Box 3055.

**DEVELOPMENT engineer**, 14 years' experience, including design and production of receiving and transmitting type capacitors, desires post with scope; now under E.W.O.—Box 3392. [4124]

**WORKS manager**, B.Sc.(Eng.), A.C.(G.I.), A.M.I.E.E., age 36, of a well known radio and television set manufacturing company, requires a new appointment in a progressive company.—Box 3390. [4119]

**INSGT. R.A.F.** 8 yrs. experience supervision, installation, test, and service M.F., V.H.F., communications, and intercomm. equipment, diploma, desires position with prospects on demobilisation, Gr. 26.—Box 3348.

**RADIO service engineer**, good theoretical knowledge and 16 years' practical experience, desires position as travelling engineer or representative; good connection North Midlands; car available.—Box 3340. [4072]

**WIRELESS mechanic**, 36, 4 yrs. civilian exp., 2 1/2 yrs. R.A.F. (servicing direction finders), release within 3 mths, desires position manager radio business; consider partnership; Southern Counties.—Box 3346.

**ELEC. Lt. Cdr.**, R.N.V.R., group 22, age 38, general electrical and radio experience (including teaching and liaison), wishes situation with established firm as technical representative, or position suitable to qualifications.—Box 3420. [4152]

**Sgt. Ltr. F. E. GODFREY**, formerly of S.F.E. Godfrey (Radio), Ltd., released after 5 1/2 yrs. R.A.F. Intelligence, seeks interesting position with reputable manufacturer; experienced custom building quality reproducers & special devices; liaison, correspondence, aide to management or similar post might suit; salary according to locality & prospects.—Portlewell House, Lamphay, Pembrokeshire. [4116]

**LONDON CENTRAL RADIO STORES**

**MOVING COIL INSERTS**  
Limited Number



Originally manufactured as Moving Coil Headphones, these can be successfully used as Midret Loudspeakers (with a suitable transformer) as Speech Microphones or can be adapted for Pick-ups. A powerful Alni Permanent Magnet energises the 1in. coil. In sealed metal case. 1 1/2in. diameter as illustrated. 8 9 each, post free.

**MULTI-RANGE Moving Coil TEST METERS**

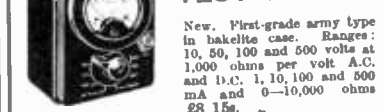

New. First-grade army type in bakelite case. Ranges: 10, 50, 100 and 500 volts at 1,000 ohms per volt A.C. and D.C. 1, 10, 100 and 500 mA and 0-10,000 ohms 23 15s.

**NEW MAINS TRANSFORMERS**

Superior Quality. 300-0.300V., 6.3v., 3 amp., 5v. 2a. Also 300-0.300V. 4v. 2a., 4v. 2a. Dim. 3 1/2 x 3. Weight, 4 1/2 lbs. Blue enamel finish. Price 24/6 each.

**MALLORY VIBRATORS. 6volt 4-pin. Unused. Slightly coiled but in perfect working order. 10/-.**



**FERRANTI Moving Coil RELAYS**  
£6 10 0

Critically balanced double hair-spring controlled movement. A.P. change-over contacts with moving contact arm fully insulated from moving coil and frame. Permanent spring bias against one fixed contact with adjustable tension. Contacts carry 40/50 ma. approx. M.C. resistance 50 ohms.

**MULTI-CONTACT SWITCHES.** Ex-Govt.. 2 1/2 x 1 1/2. Up and down, one position held. 3/6.

**METAL SCREENED CABLE.** Single, 4/6. Twin, 6/6. Treble, 9/6. Per dozen yards.

**SLIDING RESISTANCES.** 1,100 ohms 0.4 amp. wire-wound on twin porcelain formers. A first-class engineering job. 32/6.

**D.C. MOVING COIL MILLIAMMETERS** with 2in. clear reading dial, flush mounting, 0.1 mA. Full scale deflection. 47/6. 0-25 mA, 2in. dial. Flush mounting, bakelite case. Made by Ernest Turner Electrical Instruments Ltd., 50/-.

**MICROMETER**, 0-500, 2in. dial. Flush mounting, bakelite case, 24 10s.

**1 mid. TUBULAR CONDENSERS**, 5,000v. 10' wkg. 6/5

**TWO-RANGE D.C. VOLTMETERS.** Moving coil 0-300, 0-600v. Complete with shunt. 2in. clear reading dial. Flush mounting. Made by Ernest Turner Electrical Insts., Ltd. 23 17s. 6d. [4152]

**MULLARD EA50 and MAZDA D1 VALVES.** 10/6. CHASSIS 11 x 9 1/2 x 2 1/2in. 2/6.

Closed Thursdays 1 p.m. Open all day Saturdays.

**23, LISLE STREET LONDON GERard 2969 W.C.2.**

**SERGEANT** in R. Signals (demob. grp. 22), at present engaged in special W/T work, will shortly require an interesting post with radio engineering firm; holds C. and G. certificates; still studying; would welcome enquiries.—Box 3406. [4114]

**DEPARTMENTAL** manager, 33 years of age, 11 years' experience of purchase, progress, despatch, transport and goods-inwards with the most progressive firm in the radio industry (whose name is a household by-word), seeks change.—Box 1204. [3977]

**YOUNG** man, aged 24, over 5 years radio officer MN, desires position with future; passed final exams. of C. and G. in radio communication and technical electricity; interested in laboratory work, instruments, research, etc.; good education, keen and adaptable.—Box 3146. [4058]

**FIRST-CLASS** radio service engineer and sales manager, graduated in Germany, British subject, 35 years, speaks English, German, Arabic, fair knowledge French, Italian, Hebrew; at present for over seven years with British company in Middle East, wants to change his position; active, energetic, indefatigable; has built up for present employer new department from insignificance to leading position in the country; only interested in responsible and independent work for first-class firms.—Box 3389. [4118]

**TUITION**

**"ENGINEERING Opportunities."** — Free 112-page guide to training for A.M.I.Mech.E., A.M.I.E.E., and all branches of engineering and building; full of advice for expert or novice; write for free copy and make your peacetime future secure.—B.I.E.T. (Dept. 387B), 17, Stratford Place, London, W.1.

**THE Tuitionary Board** of the Institute of Practical Radio Engineers have available home study courses covering elementary, theoretical, mathematical, practical and laboratory tuition in radio and television engineering; the text is suitable coaching matter for I.P.R.E., Service-entry and progressive exams.; tuitionary fees—at pre-war rates—are moderate.—The Syllabus of Instructional Text may be obtained post free from the Secretary, Bush House, Walton Avenue, Henley-on-Thames, Oxon. [1452]

**REWINDS**

Armatures, Fields, Transformers, Pick-ups, Vacuum Cleaners, Gram, Motors, Speakers Refitted New Cones & Speech Coils.

All Guaranteed and promptly executed. Valves, B.V.A. and American, good stocks. Send stamped addressed envelope for list of Radio Spares, and C.O.D. Service.

261-3-5, Lichfield Road, A.D.S. Co. ASTON, BIRMINGHAM, 6

**TRANSFORMERS & COILS TO SPECIFICATION.**

MANUFACTURED or REWOUND.

**STANLEY CATTELL LTD.,**  
9-11, East Street, TORQUAY, Devon.  
Phone: Torquay 3108.

**LONDEX for RELAYS**



for A.C. and D.C.  
2 VA Coil consumption from 2 to 600 volts and tested to 2000 volts, Aerial Changeover Relays, Mercury Relays, Measuring Relays and Time Delay Relays.

Multiple contact Relay LF. Ask for leaflet 205/WW

**LONDEX LTD**  
MANUFACTURERS OF RELAYS  
205, SPANLEY ROAD, LONDON E 10

**HILL & CHURCHILL**  
BOOKSELLERS  
**SWANAGE DORSET**  
ENGLISH & AMERICAN BOOKS IN STOCK ON RADIO AND TELECOMMUNICATION  
CATALOGUE ON APPLICATION

*Improved Terminal*  
**CLIPS**



Well made of steel, double ridged for strength. Teeth on the sides of lower jaw and special design of upper jaw ensure firm grip and good contact.

**Wingard**  
CHURCH ROAD · HENDON · LONDON · N.W.4

**RADIO Engineering.**—Television and Wireless Telegraphy, comprehensive postal courses of instruction.—Apply British School of Telegraphy, Ltd., 179, Clapham Rd., London, S.W.9 (Estd. 9106). Also instruction at school in wireless for H.M. Merchant Navy and R.A.F. [9249]

**TECHNICAL TRAINING**

A.M.I.E.E., City and Guilds, etc., on "No pass—no fee" terms; over 90% successes. For full details of modern courses in all branches of electrical technology send for our 112-page handbook, free, post free.—B.I.E.T. (Dept. 388A), 17, Stratford Place, W.1.

**GREAT** possibilities exist for technically qualified engineers, key men in wartime and afterwards. Through the home-study courses of The T.I.G.B. take a recognised engineering qualification, such as A.M.I.Mech.E., A.M.I.E.E., A.F.R.Ae.S., A.M.I.Chem.E. C. and G., etc., in which examinations the T.I.G.B. students have passed 25 FIRST PLACES and hundreds of passes. Write today for "The Engineer's Guide to Success"—free—containing the world's widest choice of engineering courses covering all branches, including aeronautical, mechanical, electrical, wireless, chemical, etc.

**THE TECHNOLOGICAL INSTITUTE OF GREAT BRITAIN,** 82, Temple Bar House, E.C.4.  
WORK WANTED.  
DESIGN and development.

WE have facilities particularly suited to this class of work; A.I.D. approved; enquiries to:—**GREEN ELECTRICAL INDUSTRIES, Ltd.**, 44-45, Tamworth Rd., Croxford, Tel. 7417 B.

**COIL** winding, vacuum-pressure impregnating.—**Godfrey Industries, Ltd.**, Brundall, Norfolk, Tel. 90. [3604]

**CAPACITY** available for mech. elec. radio, manufacturer, large or small, simple or intricate, repairs, modifications, tropicalisation, competitive.—**Mec-Electric, Ltd.** Bank Chambers, Chatham [4005]

**WELDING** capacity, 300 hrs./wk. available on precision controlled resistance welders, projection and spot, for light alloy and steel components, assemblies and sheets up to 24in wide, thickness 2 by 1/4in.—Box No. 89, C.R.C., 29, Hertford St., W.1. [3975]

**WE LOOK FORWARD** to the restoration of our pre-war right to go ahead in our own way and improve the standard of reproduction.  
**VOIGT PATENTS LTD.**



15, SILVERDALE LONDON, S.E.26

**ROMAC RADIO CORPN. LTD**  
THE HYDE · HENDON · LONDON N.W.9  
Designers and Makers of RADIO & ELECTRONIC DEVICES

**SOUND SALES**

TRANSFORMERS—QUALITY RADIO & AMPLIFIERS.  
WEST ST., FARNHAM, SURREY.

PREPARING TO GIVE YOU THE BENEFIT OF EXTRA INVALUABLE EXPERIENCE GAINED ON WAR SERVICE

ESTABLISHED 1930.

**LUSTRAPHONE "M.C." MICROPHONES**

- Manufactured under our own patent.
- High quality sound reproduction.
- True bass without booming.
- Exceptionally well protected against shock.
- Attractive prices.

Ask for one and test it for yourself.



**LUSTRAPHONE LTD**

84, Belsize Lane, London, N.W.3 Tel.: HAMpstead 5389 and 5515



# CONDENSERS

## MINIATURE AND TROPICAL RANGES

It has long been known that to rely upon wax coating in components for tropical use was, at the best, only a compromise. Wax merely delays and does not prevent the entry of moisture, and moreover the temperature operating limits of wax-coated components are too restricted.

No alternative was available until T.C.C. engineers again pioneered the way with the tropical sealing technique described below. Now most radio engineers and set designers are familiar with the T.C.C. range of metal-cased miniature and super-tropical capacitors. Without their important equipment used in the Far East

campaigns would not have functioned. We shall be pleased to supply technical data and samples to those on essential work who have not already received them. For the present, however, the use of these capacitors is restricted to purposes laid down by the Supply Ministries.



**PAPER dielectric. Synthetic rubber end plugs. Wire end connections.**

D.C. Working Volts		Capacity Mfds.
at 71° C.	at 100° C.	
500	350	.001 to .05
350	200	.005 to .1
200	120	.05 to .1



**PAPER dielectric. Synthetic rubber-faced end discs. Wire end connections.**

D.C. Working Volts		Capacity Mfds.
at 71° C.	at 100° C.	
1000	600	.005 to .1
750	500	.02
500	350	.05 to .25
350	200	.1 to .5



**Plain foil ELECTROLYTIC. Temp. range -30° C. to +71° C. Synthetic rubber-faced end discs. Tag connections.**

Peak Working Volts		Capacity Mfds.
at 60° C.	at 71° C.	
6 to 450	6 to 350	2 to 100

(With standard intermediate voltage steps.)

(With standard intermediate capacity values.)



**Plain foil ELECTROLYTIC. Temp. range -30° C. to +71° C. Synthetic rubber end plugs. Tag connections.**

Peak Working Volts		Capacity Mfds.
at 60° C.	at 71° C.	
12 to 350	12 to 275	1 to 20

(With standard intermediate voltage steps.)

(With standard intermediate capacity values.)



**CERAMIC dielectric Synthetic rubber end plugs. Wire end connections.**

Capacity Ranges	Temperature Coefficient
10 to 1000 Mmfd.	- 800 · 10 <sup>-6</sup> per 1° C.
5 to 150 Mmfd.	+ 120 · 10 <sup>-6</sup> per 1° C.

**CONSTRUCTION:** In all of the ranges illustrated above a thin wall metal case is employed. "Metalpacks" and "Micropacks" are sealed by spinning the ends over on to synthetic rubberised discs. "Metalmites," "Picopacks" and "Metalicons" are sealed by reducing the ends on to synthetic rubber bungs, which in turn seal themselves on to the connecting wires.

The above ranges deal with Paper, Electrolytic and Ceramic capacitors; later it is hoped to offer a range known as "Micamites," which will deal with stacked Mica and Silvered Mica capacitors. These will be in flat rectangular cases following the shape of the capacitor element.

**IMPORTANT:** The proprietary names used to identify these capacitors refer exclusively to components developed and produced by T.C.C. Other products bearing similar names and not manufactured by us should not be confused with the genuine and original T.C.C. super-tropical condensers.

## THE TELEGRAPH CONDENSER CO. LTD.

RADIO DIVISION

NORTH ACTON · LONDON · W.3      TELEPHONE: ACORN 0061

## ADVERTISING Ersin Multicore ON THE OTHER SIDE OF THE ATLANTIC



FOR THOSE WHO SEEK

*The Finest*

*Cored Solder in the World*



**WE look forward** in the near future, to sending once more supplies of Ersin Multicore Solder to our friends in the U.S.A. and elsewhere overseas. Ersin Multicore contains 3 cores of non-corrosive Ersin Flux and provides just that extra rapidity of fluxing action which ensures a precision standard of consistently reliable solder joints. Only a solder wire having 3 independent cores of flux, evenly distributed across the cross-section of the solder wire, can give this extra efficiency. If you make high quality electronic equipment you will wish to learn more about Ersin—the flux contained in the 3 cores. It possesses all the non-corrosive properties of best grade Rosin but is specially activated to remove surface oxides and prevent them forming during soldering processes. It separates with a speed and gentleness which previously has never been thought possible with a non-corrosive flux. Whether you buy solder by the 1-lb. or 10,000-lb. it would give us much pleasure to send you technical literature and samples of Ersin Multicore 3 Core Solder. Just send us your name and address.



**3 CORES OF FLUX** provide just the correct proportion of flux to solder. NO extra flux is required. The flux does not tend to run out of the cores: so there is always a supply available for the next joint. The utmost economy of flux and solder is achieved.

Five standard antimony free alloys are available. Ersin Multicore Solder is supplied in bulk quantities in any other tin-lead alloy to special order. Recently 45 tin and 55 lead alloy has been in most demand for electronic equipment. Colour coding of reels and packages makes different alloys instantly recognizable.

ALLOYS—Tensile Heating Points

Alloy	Composition	Heating Point
10 SWG	60% Sn, 40% Pb	190°C
15 SWG	60% Sn, 40% Pb	190°C
22 SWG	60% Sn, 40% Pb	190°C
28 SWG	60% Sn, 40% Pb	190°C
36 SWG	60% Sn, 40% Pb	190°C
44 SWG	60% Sn, 40% Pb	190°C
50 SWG	60% Sn, 40% Pb	190°C
56 SWG	60% Sn, 40% Pb	190°C
63 SWG	60% Sn, 40% Pb	190°C
70 SWG	60% Sn, 40% Pb	190°C
78 SWG	60% Sn, 40% Pb	190°C
86 SWG	60% Sn, 40% Pb	190°C
94 SWG	60% Sn, 40% Pb	190°C
100 SWG	60% Sn, 40% Pb	190°C

**GAUGES**

Ersin Multicore Solder is made in a wide range of gauges. Standard gauges supplied are 10 SWG, 22 SWG, 28 SWG, 36 SWG, 44 SWG, 50 SWG, 56 SWG, 63 SWG, 70 SWG, 78 SWG, 86 SWG, 94 SWG, 100 SWG. 10 SWG, 22 SWG, 28 SWG, 36 SWG, 44 SWG, 50 SWG, 56 SWG, 63 SWG, 70 SWG, 78 SWG, 86 SWG, 94 SWG, 100 SWG are the most widely used sizes for the production of electronic equipment.



**ERSIN THE ACTIVE NON-CORROSIVE FLUX**

Ersin which is contained in the 3 cores of Multicore Solder is a pure high grade rosin which has been subjected to a complex chemical process to increase its fluxing action to the highest possible degree without impairing in any way the well-known non-corrosive and protective properties of the original rosin. In effect, rosin as a flux suffices only as an agent to avoid oxidation during soldering, whereas Ersin will not only remove surface oxides, but also prevent their formation during the soldering operation.

**ERSIN ACTIVE NON-CORROSIVE FLUX**

**ERSIN MULTICORE**  
THE SOLDER WIRE CONTAINING  
*3 cores* OF NON-CORROSIVE ERSIN FLUX

**MULTICORE SOLDERS LTD.**  
JUNE 5, COMMONWEALTH HOUSE, NEW-BRIDGES STREET, LONDON, W.C.1, ENGLAND  
SOLE AGENTS IN AUSTRALIA: BRITISH INDUSTRIES SALES CORPORATION, 101 SPADINA AVENUE, SYDNEY, N.S.W.  
SOLE AGENTS IN NEW ZEALAND: BRITISH INDUSTRIES SALES CORPORATION, 101 SPADINA AVENUE, SYDNEY, N.S.W.  
SOLE AGENTS IN SOUTH AFRICA: BRITISH INDUSTRIES SALES CORPORATION, 101 SPADINA AVENUE, SYDNEY, N.S.W.

**Above** is a reproduction of a double page colour advertisement now appearing overseas in such journals as the U.S.A. "Electronics." That there is a demand for Ersin Multicore in U.S.A. is particularly interesting because the production of cored solder in North America probably exceeds that made in all other countries of the world combined. Many U.S.A. and other overseas manufacturers of high quality radio

equipment find it worthwhile to import British made Ersin Multicore Solder although freight and often duty has to be paid. Most British radio manufacturers know also that the superiority of Ersin Multicore makes it more economical to use than any other form of solder. If you are not already enjoying the advantages of Multicore, please let us know.